



U R O L O G I E

REDA

INSTRUMENTE GMBH

Reda Instrumente GmbH

Gänsäcker 34 - P.O. Box 131
D-78532 Tuttlingen

Telefon +49/7462/9445-0
Telefax +49/7462/9445-20
e-mail: info@Reda-Instrumente.de
<http://www.Red-Instrumente.de>

Ausgabe Nr. 1
Datum: 2013

Charrière (Ch) French (F)	Durchmesser in mm	Inches
1	0,33	0,013
2	0,67	0,025
3	1,00	0,039
4	1,33	0,051
5	1,67	0,065
6	2,00	0,0787
7	2,33	0,092
8	2,67	0,105
9	3,00	0,1181
10	3,33	0,131
11	3,67	0,144
12	4,00	0,1575
13	4,33	0,170
14	4,67	0,184
15	5,00	0,1968
16	5,33	0,210
17	5,67	0,223
18	6,00	0,2362
19	6,33	0,249
20	6,67	0,263
21	7,00	0,2756
22	7,33	0,288
23	7,67	0,302
24	8,00	0,3150
25	8,33	0,328
26	8,67	0,341
27	9,00	0,3543
28	9,33	0,367
29	9,67	0,380
30	10,00	0,3973
31	10,33	0,407
32	10,67	0,420
34	11,33	0,446
36	12,00	0,4724
38	12,67	0,494
40	13,33	0,5199
45	15,00	0,5905

Gauge (G)	Durchmesser in mm	Inches
35	0,13	0,005
34	0,18	0,007
33	0,20	0,008
32	0,23	0,009
31	0,25	0,010
30	0,30	0,012
29	0,33	0,013
28	0,36	0,014
27	0,41	0,016
26	0,46	0,018
25	0,51	0,020
	0,53	0,021
24	0,56	0,022
23	0,64	0,025
22	0,71	0,028
21	0,81	0,032
20	0,89	0,035
	0,97	0,038
19	1,07	0,042
18	1,27	0,050
17	1,50	0,059
16	1,65	0,065
15	1,83	0,072
14	2,11	0,083
13	2,41	0,095
12	2,77	0,109
11	3,05	0,120
10	3,40	0,134
9	3,76	0,148
8	4,19	0,165
7	4,57	0,180
6	5,16	0,203

1 OZ	0,028 ml
5 OZ	0,140 ml
16 OZ	0,450 ml

35 OZ	1,0 l
128 OZ	3,7 l

GARANTIE / WARRANTY / GARANTIA / GARANZIA

GARANTIE

Wir gewähren auf alle **Reda**-Instrumente 5 Jahre Garantie. Voraussetzung ist der sach- und fachgerechte Einsatz der Instrumente.

Von der Garantie sind Verschleißerscheinungen ausgeschlossen.

WARRANTY

Our **Reda** products are free from manufacturing defects in material and workmanship. We therefore give on all instruments a guarantee of five years provided that the instruments are maintained and cleaned properly and used normally for their intended purpose.

GARANTIA

Estamos convencidos de nuestra calidad y concedemos a todos los instrumentos de **Reda** 5 años de garantía contra cualquier defecto de fabricación, siempre y cuando se usen adecuadamente. De la garantía excluimos la manifestación de desgaste.

GARANZIA

Siamo convinti della nostra qualità e concediamo cinque anni di garanzia sulla funzione dei tutti gli strumenti **Reda** sotto la presupposizione che l'utilizzo è da esperto.

Escluso della garanzia sono tracce di consumo.

OPTIKEN	7 - 8
TELESCOPES	
ÓPTICAS	
OTTICHE	
<hr/>	
CYSTOSKOPIE	9 - 20
CYSTOSCOPY	
CISTOSCOPIA	
CISTOSCOPIA	
<hr/>	
RESEKTOSKOPIE	21 - 28
RESECTOSCOPY	
RESECTOSCOPIA	
RESETTOSCOPIA	
<hr/>	
URETHROTOM	29 - 32
URETHROTOME	
URETRÓTOMO	
URETROTOMO	
<hr/>	
CYSTOSKOPIE FÜR 2,9 MM Ø OPTIK	33 - 38
CYSTOSCOPY FOR 2,9 MM Ø OPTIC	
CISTOSCOPIA PARA ÓPTICA 2,9 MM Ø	
CISTOSCOPIA PER OTTICA 2,9 MM Ø	
<hr/>	
RESEKTOSKOPIE FÜR 2,9 MM Ø OPTIK	39 - 46
RESECTOSCOPY FOR 2,9 MM Ø OPTIC	
RESECTOSCOPIA PARA ÓPTICA 2,9 MM Ø	
RESETTOSCOPIA PER OTTICA 2,9 MM Ø	
<hr/>	
URETHROTOMIE FÜR 2,9 MM Ø OPTIK	47 - 50
URETHROTOMY FOR 2,9 MM Ø OPTIC	
URETRÓTOMO PARA ÓPTICA 2,9 MM Ø	
URETROTOMO PER OTTICA 2,9 MM Ø	
<hr/>	
PÄDIATRISCHE UROLOGIE / CYSTOSKOPIE UND RESEKTOSKOPIE, 9,5 & 11 CHAR Ø	51 - 56
PEDIATRIC UROLOGY / CYSTOSCOPY AND RESECTOSCOPY, 9,5 & 11 FR. Ø	
UROLOGÍA PEDIÁTRICA / CISTOSCOPIA Y RESECTOSCOPIA, 9,5 & 11 CHAR Ø	
UROLOGIA PEDIATRICA / CISTOSCOPIA E RESETTOSCOPIA, 9,5 & 11 CHAR Ø	

PÄDIATRISCHE UROLOGIE / CYSTOSKOPIE UND RESEKTOSKOPIE, 13 CHAR Ø	57 - 62
PEDIATRIC UROLOGY / CYSTOSCOPY AND RESECTOSCOPY, 13 FR. Ø	
UROLOGÍA PEDIÁTRICA / CISTOSCOPIA Y RESECTOSCOPIA, 13 CHAR Ø	
UROLOGIA PEDIATRICA / CISTOSCOPIA E RESECTOSCOPIA, 13 CHAR Ø	

NEPHROSKOPIE	63 - 66
NEPHROSCOPY	
NEFROSCOPIA	
NEFROSCOPIA	

URETERO-RENOSKOPIE	67 - 72
URETERO-RENOSCOPY	
URETERO-RENOSCOPIA	
URETERO-RENOSCOPIA	

ZUBEHÖR	73 - 78
ACCESSORIES	
ACCESORIOS	
ACCESSORI	

NUMMERNVERZEICHNIS	79 - 81
NUMERICAL INDEX	
INDICE NUMÉRICO	
INDICE NUMERICO	

Reda Instrumente GmbH
Gänsäcker 34 - P.O. Box 131
D-78532 Tuttlingen

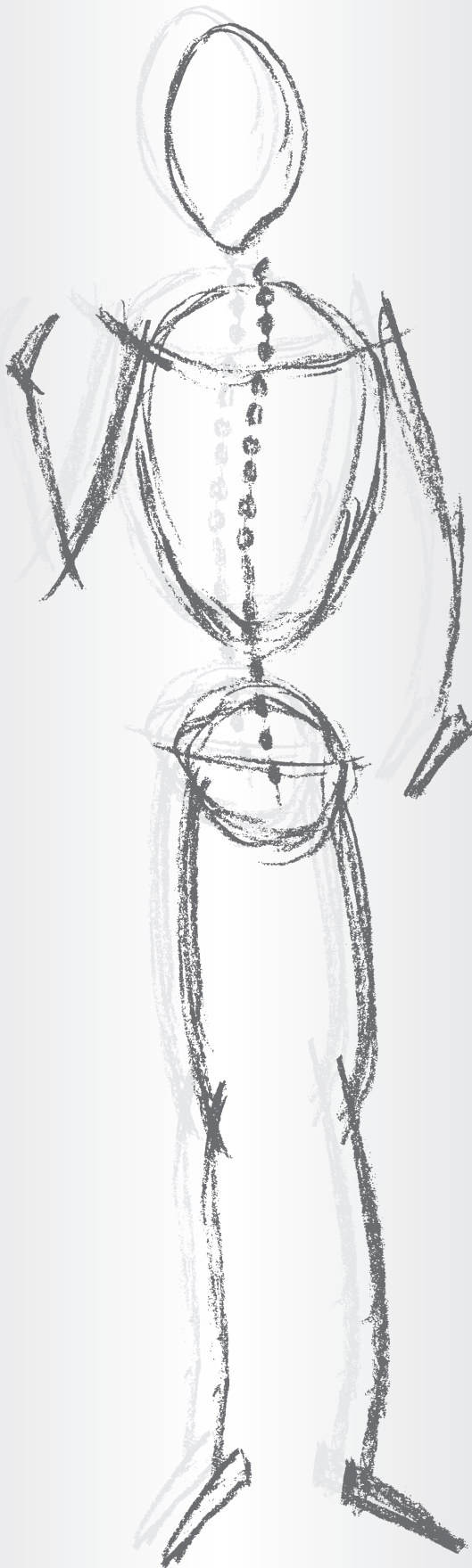

OPTIKEN

TELESCOPES

ÓPTICAS

OTTICHE



www.Reda-Instrumente.de

Cystoskope 302 mm Nutzlänge, integrierte Fiberoptik Faser für Beleuchtung, autoklavierbar
Cystoscopes 302 mm working length, incorporated fiber optic bundle for illumination, autoclavable
Cistoscopio 302 mm longitud, con conductor de luz de fibra, esterilizable e autoclavable
Optica Cistoscopio lunghezza utile 302 mm a vision con conduttore di luce a fibre ottiche



Blickrichtung
Angle of view
Dirección visual
Angolo di visione

Ø 4,0 mm

0°	R300-040302-000
15°	R300-040302-015
30°	R300-040302-030
70°	R300-040302-070

Reda Instrumente GmbH
Gänsäcker 34 - P.O. Box 131
D-78532 Tuttlingen

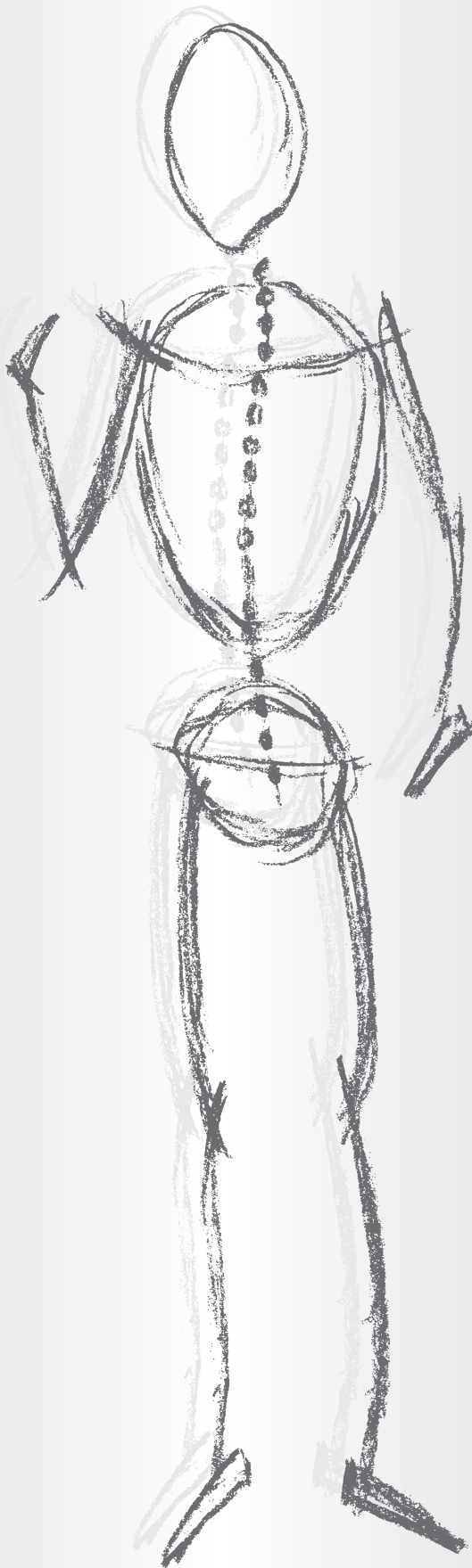

CYSTOSKOPIE

CYSTOSCOPY

CISTOSCOPIÁ

CISTOSCOPIA



www.Reda-Instrumente.de

Cystoskop-Schäfte, 2 Hähne fest mit LL-Adapter
 Cystoscopy sheaths, 2 stop cocks fixed with LL-adapters
 Camisas para cistoscopia, 2 valvas nigras adaptador de LL
 Camicia per cistoscopia, 2 rubinetti fissi con adattatore LL

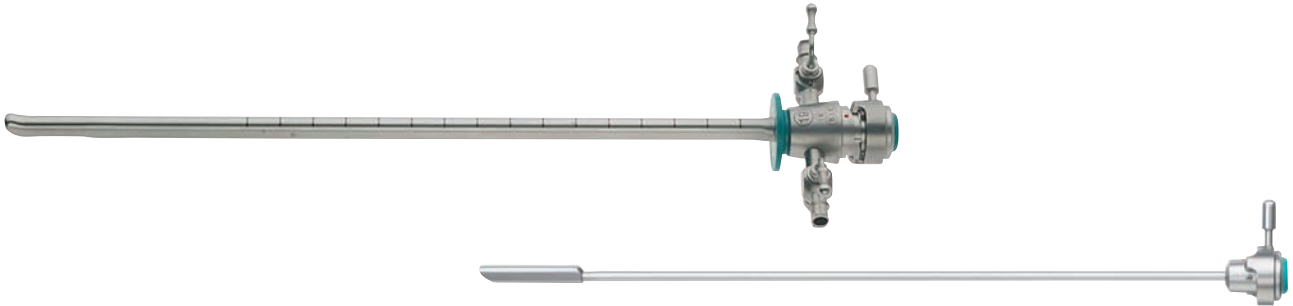

Ø [Char]	Obturator	Sheath	Sheath + Obturator	Colour Code
17	R310-170000-001	R310-170235-001	R311-170235-001	Yellow
19	R310-190000-001	R310-190235-001	R311-190235-001	Green
21	R310-210000-001	R310-210235-001	R311-210235-001	Red
23	R310-230000-001	R310-230235-001	R311-230235-001	Blue
25	R310-250000-001	R310-250235-001	R311-250235-001	White



	Ø [Char]	
Sichtobturator für Cystoskopschaft	17	R310-170000-003
Visual obturator for cystoscope sheath	19	R310-190000-003
Obturador visual para camisa de cistoscopia	21	R310-210000-003
Otturatore di visualizzazione	23	R310-230000-003
	25	R310-250000-003

Cystoskop-Schaft, Zentralhahn mit LL-Adapter
Cystoscopy sheath, central valve fixed with LL-adapters
Camisas para cistoscopio, valvula central con adaptador de LL
Camicia cistoscopio, 2 rubinetti fissi dotato di rubinetto centrale con ingresso LL



Ø [Char]	Obturator	Sheath	Sheath + Obturator	Colour Code
17	R310-170000-001	R312-170235-001	R313-170235-001	Yellow
19	R310-190000-001	R312-190235-001	R313-190235-001	Green
21	R310-210000-001	R312-210235-001	R313-210235-001	Red
23	R310-230000-001	R312-230235-001	R313-230235-001	Blue
25	R310-250000-001	R312-250235-001	R313-250235-001	White

Cystoskopie - Optikbrücken Ø 4 mm
Cystoscopy - Telescope bridges Ø 4 mm
Cistoscopia - Puente para optica de Ø 4 mm
Cistoscopio - Ponticello Ø 4 mm

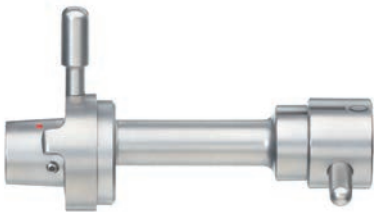
**R310-040000-000**

Optikbrücke für Diagnose
Telescope bridge for diagnostic
Puente para optica para el diagnostico
Ponticello diagnostico per visione diretta

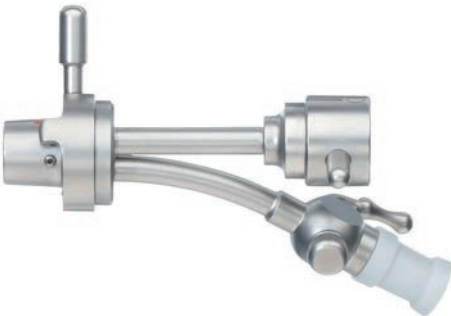
**R310-040000-001**

Optikbrücke mit 1 Instrumentenkanal verschließbar
Telescope bridge with 1 instrument channel lockable
Puente para optica con 1 canal obturable para instrumental
Ponticello diagnostico con 1 ingresso

**R310-040000-002**

Optikbrücke mit 2 Instrumentenkanal verschließbar
Telescope bridge with 2 instrument channel lockable
Puente para optica, con 2 canales obturables para instrumental
Ponticello diagnostico con 2 ingressi

Cystoskopie - Arbeitseinsatz mit Albarran-Lenkhebel
 Cystoscopy - Working-element with Albarran deflector
 Cistoscopia - vaina de trabajo con palanca conductor tipo Albarran
 Cistoscopio - Inserto operativo con leva di ALBARRAN



1 Instrumentenkanal	W/O ratchet	W ratchet
1 instrument channel		
1 canal para instrumentos	R310-040000-011	R310-040000-021
1 canale per strumenti		

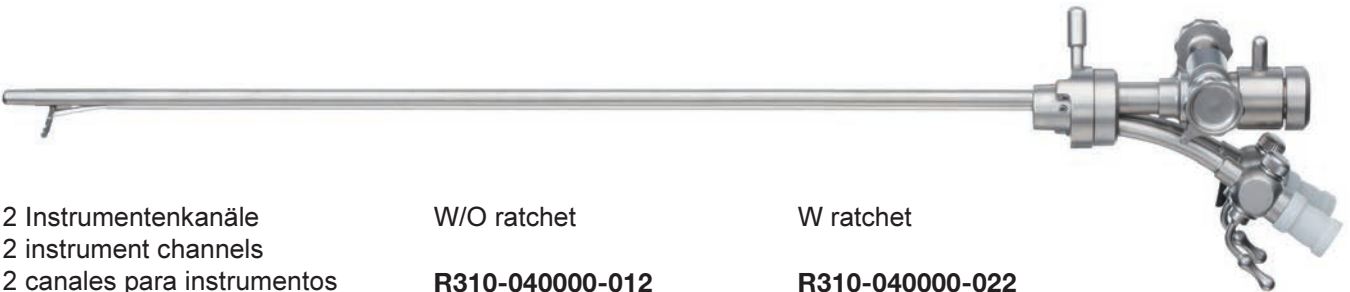

2 Instrumentenkanäle	W/O ratchet	W ratchet
2 instrument channels		
2 canales para instrumentos	R310-040000-012	R310-040000-022
2 canali per strumenti		



NICKELL Cystoskop Adapter für Frauen	R319-900-01
NICKELL cystoscope adapter for women	
NICKELL adaptador cistoscopico para mujeres	
NICKELL adattatore per donne	

Optische Instrumente für Cystoskopschäfte ab 21 Char Ø
Optical instruments suitable for cystoscope sheath up on 21 Char Ø
Instrumental optico para vainas cistoscópicas de 21 Char Ø
Instrumenti ottici per camicia cistoscopica 21 Char Ø



Biopsiezange
Biopsy forceps
Pinza biopsia
Pinza per biopsia

R315-021000-01



Biopsiestanze
Biopsy punch
Pinza biopsia
Pinza tagliente per biopsia

R315-021000-06



Schere
Scissor
Tijera
Forbici

R315-021000-021



Faßzange
Grasping forceps
Pinza de agarre
Pinza per presa

R315-021000-011

Optische Instrumente für Cystoskopschäfte ab 21 Char Ø
Optical instruments suitable for cystoscope sheath up on 21 Char Ø
Instrumental optico para vainas cistoscopicas de 21 Char Ø
Instrumenti ottici per camicia cistoscopica 21 Char Ø

Probeexzisionszange, optisch
Biopsy punch, optical
Pinza de biopsia, óptica
Pinza per biopsia con canale per ottica



30° **R315-021000-30**

70° **R315-021000-70**

Adapter f. Resektoskop Schäfte
Adaptor f. resectoscope sheath
Adaptador para vainas resectoscopicas
Adattatore per camicie resettoscopio





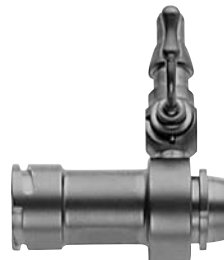



R315-901









R315-902

Flexible Instrumente 40 cm
 Flexible instruments 40 cm
 Instrumentos flexible 40 cm
 Instrumenti Flessibili 40 cm

Nutzlänge von 34 cm auf Anfrage erhältlich
Length of 34 cm available on request
Largo util de 34 cm disponible a petición
Lunghezza utile 34 cm disponibile su richiesta

	Ø 5 [Char]	Ø 6 [Char]	Ø 7 [Char]	Ø 9 [Char]
 <p>Biopsiezange Bopsy forceps Pinza de biopsia Pinza per biopsia con doppia articolazione</p>	R392-017400-001	R392-021400-001	R392-023400-001	R392-030400-001
 <p>Löffel gezahnt Foreign body, short Cuchara dentada Pinza per la rimozione con doppia articolazione</p>	R392-017400-003	R392-021400-003	R392-023400-003	R392-030400-003
 <p>Biopsiezange einfachbeweglich Bopsy punch single action Pinza para biopsia articulacion simple Pinza per biopsia mono articolata</p>			R392-023400-004	
 <p>Löffel oval Spoon Forceps Cuchara oval Cucchiaino ovale con denti aggressivi</p>	R392-017400-005	R392-021400-005	R392-023400-005	
 <p>Fasszange Grasping forceps Pinza de agarre Pinza da presa con doppia articolazione</p>		R392-021400-006		
 <p>Fremdkörperzange Foreign body forceps Pinza para cuerpos extraños Pinza da presa per corpi estranei, mono articolata</p>			R392-023400-009	

Nutzlänge von 34 cm auf Anfrage erhältlich
Length of 34 cm available on request
Largo util de 34 cm disponible a petición
Lunghezza utile 34 cm disponibile su richiesta

	Ø 5 [Char]	Ø 6 [Char]	Ø 7 [Char]	Ø 9 [Char]
 <p>Fremdkörper-Zange Foreign body forceps Pinza para cuerpos extraños Pinza da presa per corpi estranei con doppia articolazione</p>			R392-023400-010	
 <p>Alligatorfaßzange Alligator grasping forceps Pinza de agarre tipo caiman Pinza da presa tipo alligator con doppia articolazione</p>	R392-017400-011	R392-021400-011	R392-023400-011	R392-030400-011
 <p>Steinzange Stone grasping forceps Pinza para calculus Pinza da presa per calculi con doppia articolazione</p>			R392-023400-014	
 <p>Schere Scissor Tijera Forbici mono articolata</p>	R392-017400-021	R392-021400-021	R392-023400-021	R392-030400-021
 <p>Schere doppelt beweglich Scissor, double action Tijera, articulacion doble Forbici con doppia articolazione, lama seghettata</p>			R392-023400-022	
 <p>Hakenschere Hook scissor Tijera en forma de gancho Forbici rette uncinata mono articolate</p>			R392-023400-023	R392-030400-023

Dormia Steinfänger
Dormia stone dislodger
Malla para rescadar calculus
Cestello dormia

**R394-017600-004**

4 Drähte, 5 Char Ø, 600 mm Nutzlänge
4 wires, 5 Fr. Ø, 600 mm work.length
Extractor de calculus de 4 alambres 5 Char Ø, 600 mm de largo util
Cestello dormia 4 filamenti, lunghezza 600 mm



R394-017600-006

6 Drähte, 5 Char Ø, 600 mm Nutzlänge
6 wires, 5 Fr. Ø, 600 mm work.length
Extractor de calculus de 6 alambres 5 Char Ø, 600 mm de largo util
Cestello dormia 6 filamenti, lunghezza 600 mm

**R394-000000-000**

Griff für Dormia Steinfänger
handle for Dormia stone dislodger
mango para Malla para rescadar calculus
Impugnatura per Cestello dormia

Koagulationselektroden, flexibel
 Coagulation electrodes, flexible
 Electrodo para coagulación, flexible
 Elettrodo per coagulazione, flessibile

	Ø 3 [Char]	Ø 5 [Char]	Ø 7 [Char]	Ø 9 [Char]
 <p>Knopf Ball end Bola Sfera</p>	R395-010450-001	R395-017450-001	R395-023450-001	R395-030450-001
 <p>Nadel Needle type Aguja Ago</p>	R395-010450-021	R395-017450-021	R395-023450-021	
 <p>Schlinge Loop Asa Ansa</p>		R395-017450-011	R395-023450-011	R395-030450-011

Polypektomie-Schlinge
 Polypectomy loop
 Asa para polipectomia
 Ansa per polipectomia



Ø 5 [Char]
 R395-017400-125

Ø 7 [Char]
 R395-023400-125

Handgriff mit HF Anschluß für Diathermie Schlinge
 Handle w. HF connector for diathermy loop
 Mango con conexión de alta frecuencia para asa de diatermia
 Impugnatura per dormia con cursore ad anello dotata di attacco monopolare



R395-000000-000

Lithotripsie
Lithotripsy
Litotripsia
Litotripsia

**R315-250000-39** (for 25 Char)

Steinzange
Stone grasping forceps
Pinza para cálculo
Pinza per calcoli

**R315-902**

Adapter für Steinzange
Adapter for grasping forceps
Adaptador para el uso de la pinza para cálculo
Adattore con rubinetto per l'uso delle pinze per calcoli

**R315-240000-59**

Arbeitselement zur Stanz-Lithotripsie; optisch, 24 Char
Working element for punch lithotripsy; optical, 24 Fr.
Element de trabajo para litotripsia; óptico, 24 Char
Strumento ottico, 24 Char di lavoro operativo per litotripsia

**R313-240235-001**

Lithotripsie Schaft mit Zentralhahn 24 Char
Lithotripsy sheath with central valve, 24 Fr.
Vaina para litotripsia con llave central, 24 Char
Camicia per litotripsia con rubinetto centrale, 24 Char

**R310-240000-001**

Obturator Standard; für Lithotripsie Schaft 24 Char
Obturator standard; for lithotripsy sheath 24 Fr.
Obturator estándar; para vaina de litotripsiá 24 Char
Otturatore standard; per camicia litotriptisia 24 Char

**R312-240000-001**

Optikbrücke mit 1 Instrumentenkanal 24 Char
Telescope bridge; 1 instrument channel 24 Fr.
Puente óptico; 1 canal para instrumentos 24 Char
Ponte per telescopio con 1 canale per strumenti 24 Char

Reda Instrumente GmbH
Gänsäcker 34 - P.O. Box 131
D-78532 Tuttlingen

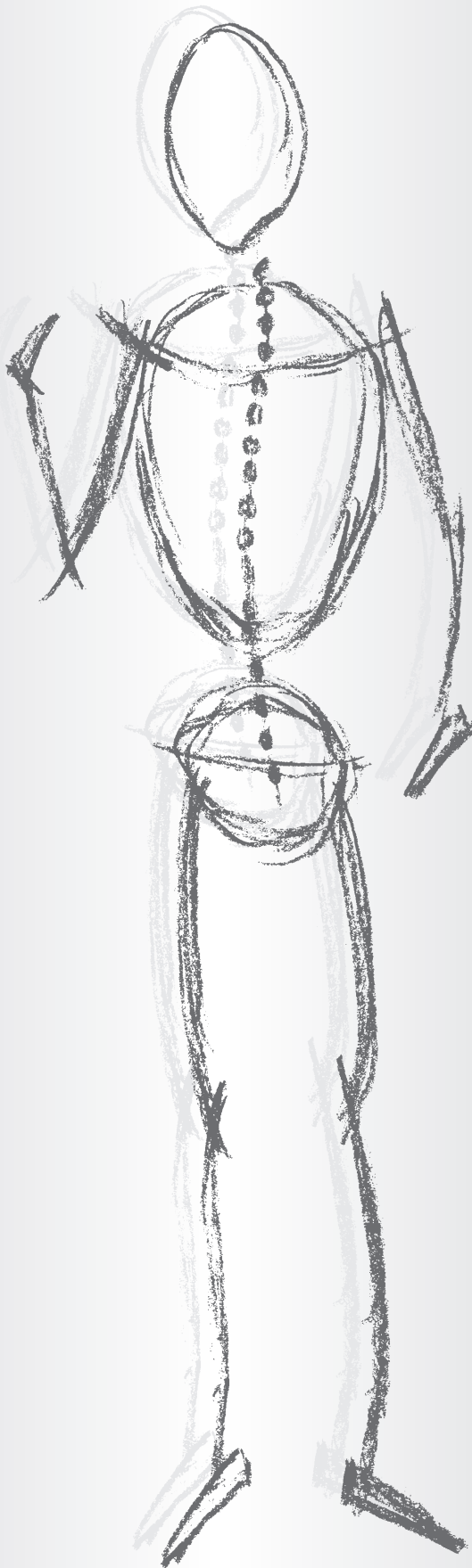

RESEKTOSKOPIE

RESECTOSCOPY

RESECTOSCOPIÁ

RESECTOSCOPIA



www.Reda-Instrumente.de

Arbeitselement für Ø 4 mm Optik
Working element for Ø 4 mm optic
Elemento de trabajo para óptica Ø 4 mm
Elemento di lavoro per l'uso con ottica Ø 4 mm

"AKTIV", schneidend durch Fingerdruck
"ACTIVE", cutting by finger action
"ACTIVO", cortante por la presión del dedo
Impugnatura con movimento "ATTIVO"

**R320-040225-11**

Griff geschlossen
Closed handle
Mango cerrado
Manico con anello chiuso

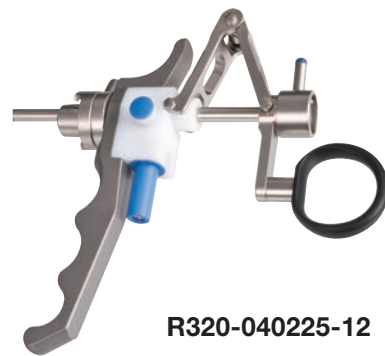
**R320-040225-12**

Griff offen
Opened handle
Mango abierto
Manico aperto

Arbeitselement "PASSIV", schneiden durch Federzug
Working element "PASSIVE", cutting by spring action
Elemento de trabajo "PASSIVO", cortante por balancin
Elemento di lavoro con movimento "PASSIVO"

**R320-040225-01**

Griff geschlossen
Closed handle
Mango cerrado
Manico con anello chiuso

**R320-040225-02**

Griff offen
Opened handle
Mango abierto
Manico aperto

Hochfrequenzkabel, monopolar, für Geräte von:
High frequency cable, monopolar, for devices of:
Cable monopolar de alta frecuencia, para equipos de:
Cavo monopolare ad alta frequenza per apparecchi:



4 mm

Eschmann alte Gerät, Erbe T-Serie old units
R329-040000-003 3 mtr.
R329-040000-005 5 mtr.



4 mm

Aesculap, Berchtold, Martin
R329-040000-203 3 mtr.
R329-040000-205 5 mtr.



5 mm

Erbe, Storz
R329-050000-003 3 mtr.
R329-050000-005 5 mtr.



8 mm

Valleylab
R329-080000-003 3 mtr.
R329-080000-005 5 mtr.

Dauerspül Resektoskop-Schäfte
 Resectoscope sheats, continuous flow
 Vaina para resectoscopio con flujo continuo
 Camicia resettore, a aspirazione continua



Innenschaft, ohne Spülhahn mit LL-Adapter
 Inner Sheat, without irrigation stop cock with LL-adapter
 Vaina interior, valvula de irrigacion sin adaptador de LL
 Camicia interna, attacco LL senza rubinetto fisso

Ø [Char]

24	Drehbar Rotatable rotable	R320-240000-130
	Nicht drehbar Not rotatable non rotabile	R320-240000-030
27	Drehbar Rotatable rotable	R320-270000-130
	Nicht drehbar Not rotatable non rotabile	R320-270000-030

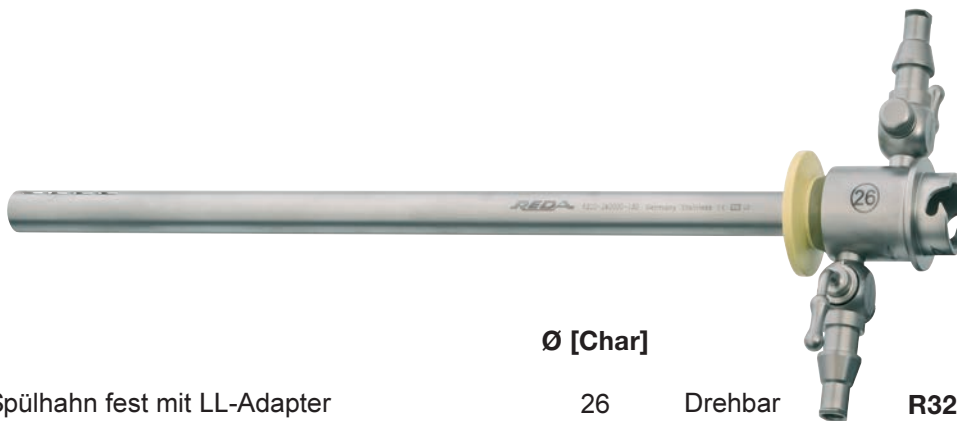

Außenschaft, 2 Spülhahn fest mit LL-Adapter
 Outer Sheat, 2 irrigation stop cock with LL-adapter
 Vaina exterior, 2 valvula de irrigacion con adaptador de LL
 Camicia esterna, attacco LL con 2 rubinetti fissi

Ø [Char]

26	Drehbar Rotatable rotable	R320-260000-130
	Nicht drehbar Not rotatable non rotabile	R320-260000-030
28,5	Drehbar Rotatable rotable	R320-285000-130
	Nicht drehbar Not rotatable non rotabile	R320-285000-030

Dauerspül Resektoskop-Schäfte
 Resectoscope sheats, continuous flow
 Vaina para resectoscopio con flujo continuo
 Camicia resettore, a aspirazione continua



Ø [Char]

Kombinierte Schäfte
 Combi sheats
 Vainas combinadas
 Camicia con combinazione

24 / 26	Drehbar Rotatable rotabile	R320-260240-130
	Nicht drehbar Not rotatable non rotabile	R320-260240-030
27 / 28,5	Drehbar Rotatable rotabile	R320-285270-130
	Nicht drehbar Not rotatable non rotabile	R320-285270-030

Resektoskopie Obturatoren
 Resectoscopy obturators
 Obturador para resectoscopia
 Otturatori per resettoscopia







Standard Obturator	Ø [Char]	
Standard obturators	24	R320-240000-001
Obturador estandar	27	R320-270000-001
Standard otturatore		







Obturator, krümmbar	Ø [Char]	
Obturator deflectable	24	R320 240000-002
Obturador flexible	27	R320-270000-002
Otturatore mono aticolato		



Sicht-Obturatot	Ø [Char]		
Visual Obturator	24	ohne Kanal without channel sin canal	R320-240000-003
Obturador visual		mit Kanal with channel con canal	R320-240000-005
Otturatore diagnostico per visualizzazione diretta			
	27	ohne Kanal without channel sin canal	R320-270000-003
		mit Kanal with channel con canal	R320-270000-005

		Ø 24 [Char]	Ø 27 [Char]
	Schlinge retrograde gebogen Loop, retrograde curved Electrodo de asa, curva retrogradamente Ansa per taglio, angolata	R329-240000-001 (for 0° Optic) R329-240030-001 (for 30° Optic)	R329-270000-001 (for 0° Optic) R329-270030-001 (for 30° Optic)
	Schlinge gerade Loop, straight Asa recta Ansa per taglio, ad asso longitudinale	R329-240010-001	R329-270010-001
	Kugel Ball Bola sferico	R329-240040-003 (Ø 3 mm) R329-240040-005 (Ø 5 mm)	R329-270040-003 (Ø 3 mm) R329-270040-005 (Ø 5 mm)
	Rolle Roller barrel Rollo Rullo	R329-240050-003 (Ø 3 mm) R329-240050-005 (Ø 5 mm)	R329-270050-003 (Ø 3 mm) R329-270050-005 (Ø 5 mm)
	Vaporisationsschlinge Vaporisation Loop Asa de vaporisacion Elettrodo per vaporizzazione	R329-240055-001 (for 0° Optic) R329-240056-001 (for 30° Optic)	R329-270055-001 (for 0° Optic)

Monopolare Elektroden
 Monopolar electrodes
 Electrodo monopolar
 Elettrodo monopolare

		Ø 24 [Char]	Ø 27 [Char]
	Vaporisationselektrode Vaporisation electrode Electrodo de vaporisation Elettrodo a rullo per vaporizzazione	R329-240052-003 (Ø 3 mm) R329-240052-005 (Ø 5 mm)	R329-270052-003 (Ø 3 mm) R329-270052-005 (Ø 5 mm)
	Spike Spike electrode Electrodo de Spike Elettrodo di Spike	R329-240054-003 (Ø 3 mm) R329-240054-005 (Ø 5 mm)	
	Kegel Cone Cono Conico	R329-240090-003	
	Messer Knife Cuchillo Elettrodo di coagulazione a bisturi	R329-240070-001	R329-270070-001

R329-990



Sterilisierhülse für Elektroden
 Sterilization tube for electrodes
 Embudo para esterilizacion de electrodos
 Tubo di protezione per elettrodi

Reda Instrumente GmbH
Gänsäcker 34 - P.O. Box 131
D-78532 Tuttlingen

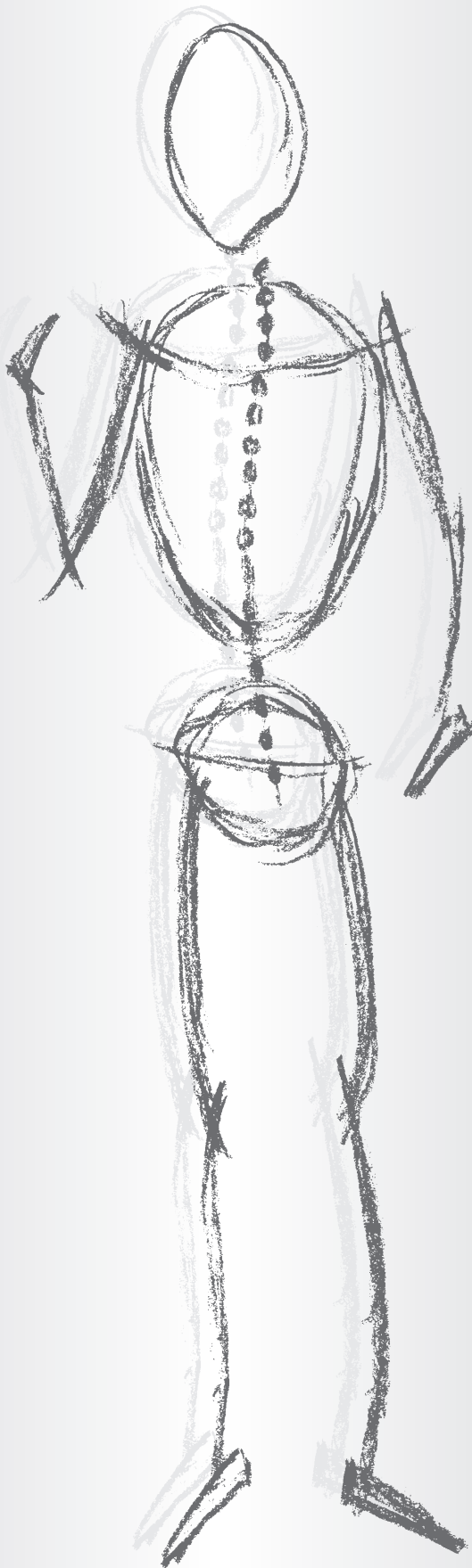

URETHROTOM

URETHROTOME

URETRÓTOMO

URETROTOMO



www.Reda-Instrumente.de

Urethrotomie
Urethrotomy
Uretrotomia
Uretrotomia

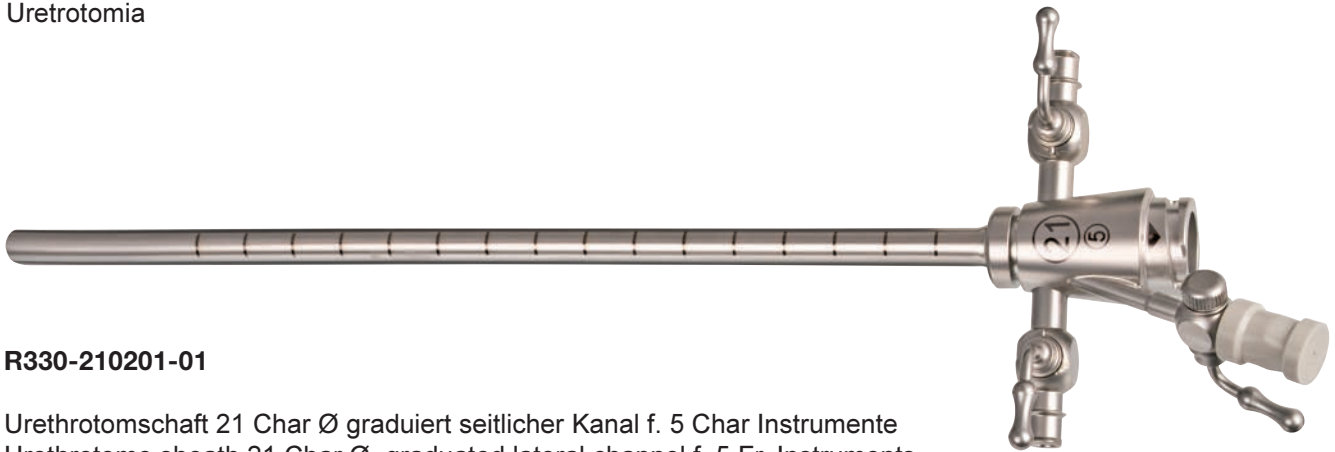
**R330-210201-01**

Urethrotomschaft 21 Char Ø graduiert seitlicher Kanal f. 5 Char Instrumente
Urethrotome sheath 21 Char Ø, graduated lateral channel f. 5 Fr. Instruments
Vaina para uretrotomo de 21 Char Ø con canal graduado lateral para instrumentos de 5 Char
Camicia per uretrotomo 21 Char Ø

**R330-230201-001**

Zusatzschaft für Urethrotom, seitlich offen
Supplementary sleeve, lateral open
Vaina adicional para uretrotomo, apertura lateral
Camicia supplementare, aperta lateralmente

**R330-230201-102**

Dauerspül Zusatzschaft für Urethrotomschaft 21 Char Ø
Continuous Flow supplementary sleeve for urethrotom-sleeve 21 Char Ø
Vaina adicional para irrigación continua para uretrotomo de 21 Char Ø
Camicia supplementare a lavaggio continuo 21 Char Ø per camicia per uretrotomo



R330-210000-01

Urethrotom Standard Obturator für 21 Char Ø Schaft #R330-210201-01
Urethrotome standard obturator for 21 Char Ø sheath #R330-210201-01
Obturador estándar para uretrótomo de 21 Char Ø vaina #R330-210201-01
Otturatore, per camicia per uretrotomo, 21 Char Ø #R330-210201-01



R330-210000-11

Urethrotom Standard Obturator für 21 Char Ø mit Arbeitskanal
Urethrotome standard obturator for 21 Char Ø with instrument channel
Obturador estándar para uretrótomo de 21 Char Ø con 1 canal para instrumentos
Otturatore, per camicia per uretrotomo, 21 Char con 1 canale operative per strumenti

R339-040000-001

Optikbrücke
Telescope bridge
Puente para optica
Ponticello per uretrotomo

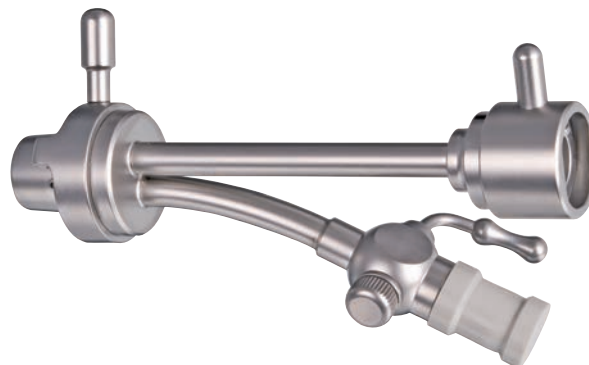

Strikturmesser
Cold knife
Cuchillo de corte frio
Lama uretrotomo per taglio a freddo



R339-210000-001
gerade
straight
recto
retto



R339-210000-002
Wellenschliff
wave shaped
filo ondulado
affilatura ondulata



R339-210000-011
rund
round shaped
semicircular
semisferico



R339-210000-021
ringförmig
ring shaped
en forma de anillo
ad anello



R339-210000-031
sichelförmig
sickle shaped
en forma de hoz
ad uncino

Reda Instrumente GmbH
Gänsäcker 34 - P.O. Box 131
D-78532 Tuttlingen

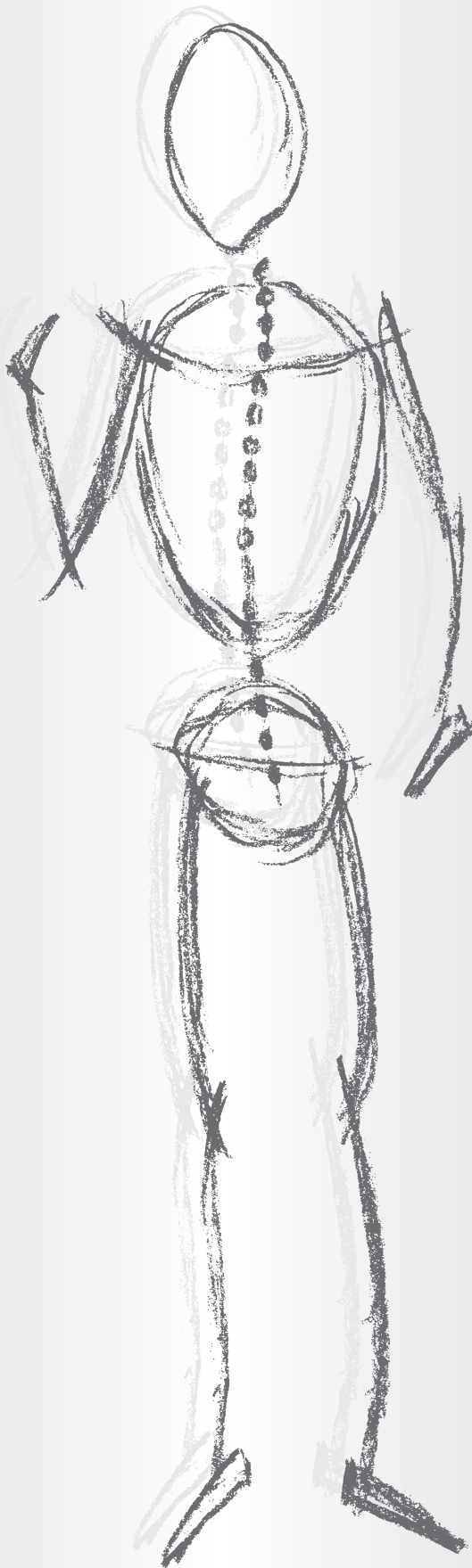

CYSTOSKOPIE
für 2,9 mm Ø Optik

CYSTOSCOPY
for 2,9 mm Ø optic

CISTOSCOPIÁ
para óptica 2,9 mm Ø

CISTOSCOPIA
per ottica 2,9 mm Ø



www.Reda-Instrumente.de

Cystoskope 302 mm Nutzlänge, integrierte Fiberoptik Faser für Beleuchtung, autoklavierbar
Cystoscopes 302 mm working length, incorporated fiber optic bundle for illumination, autoclavable
Cistoscopio 302 mm longitud, con conductor de luz de fibra, esterilizable e autoclavable
Cistoscopio lunghezza utile 302 mm, con conduttore di luce a fibre ottiche sterilizzabile in autoclave



Blickrichtung
Angle of view
Dirección visual
Angolo di visione

Ø 2,9 mm

0°	R300-029302-000
15°	R300-029302-015
30°	R300-029302-030
70°	R300-029302-070

Cystoskop-Schäfte
Cystoscopy sheaths
Camisas para cistoscopia
Camicie per cistoscopia



Ø [Char] 15

Cystoskop-Schaft, 2 Hähne fest mit LL-Adapter
Cystoscopy sheath, 2 stop cocks fixed with LL-adapters
Camisa para cistoscopia, 2 valvulas con adaptador de LL
Camicia cistoscopia, 2 rubinetti fissi incluso, 2 coni LL

Obturator	R310-150000-001
Sheath + Obturator	R310-150235-001
Sheath	R311-150235-001

Cystoskopie - Optikbrücken
Cystoscopy - Telescope bridges
Cistoscopia - Puente para optica
Cistoscopio - Ponticello

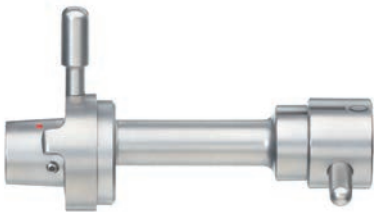
**R310-029000-000**

Optikbrücke für Diagnose
Telescope bridge for diagnostic
Puente para optica para el diagnostico
Ponticello diagnostico per visione diretta

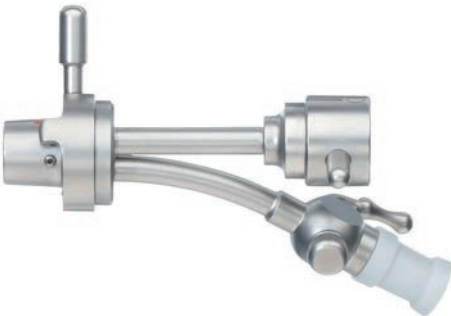
**R310-029000-001**

Optikbrücke mit 1 Instrumentenkanal verschließbar
Telescope bridge with 1 instrument channel lockable
Puente para optica con 1 canal obturable para instrumental
Ponticello diagnostico con 1 canale

**R310-029000-002**

Optikbrücke mit 2 Instrumentenkanal verschließbar
Telescope bridge with 2 instrument channel lockable
Puente para optica con 2 canales obturables para instrumental
Ponticello diagnostico con 2 canali

Cystoskopie - Arbeitseinsatz mit Albarran-Lenkhebel
Cystoscopy - Working-element with Albarran deflector
Cistoscopia - vaina de trabajo con palanca conductor tipo Albarran
Cistoscopio - Inserto operativo con leva di ALBARRAN



R310-029000-011

Arbeitseinsatz mit Albarran-Lenkhebel, 1 Instrumentenkanal
Working-element with Albarran deflector, 1 instrument channel
Vaina de trabajo con palanca conductora tipo Albarran, 1 canal para instrumental
Inserto operativo con leva di ALBARRAN con 1 ingresso







R310-029000-012

Arbeitseinsatz mit Albarran-Lenkhebel, 2 Instrumentenkanäle
Working-element with Albarran deflector, 2 instrument channels
Vaina de trabajo con palanca conductora tipo Albarran, 2 canales para instsrumental
Inserto operativo con leva di ALBARRAN con 2 ingressi

Flexible Instrumente 40 cm
 Flexible instruments 40 cm
 Instrumentos flexible 40 cm
 Instrumenti Flessibili 40 cm

Nutzlänge von 34 cm auf Anfrage erhältlich
Length of 34 cm available on request
Largo util de 34 cm disponible a petición
Lunghezza utile 34 cm disponibile su richiesta

	Ø 5 [Char]	Ø 4 [Char]	Ø 3,5 [Char]	Ø 3 [Char]
 <p>Biopsiezange Biopsy forceps Pinza de biopsia Pinza per biopsia con doppia articolazione</p>	R392-017400-001	R392-014400-001	R392-012400-001	R392-010400-001
 <p>Löffel oval Spoon Forceps Cuchara oval Cucchiaino ovale con denti aggressivi</p>	R392-017400-005			R392-010400-005
 <p>Alligatorfaßzange Alligator grasping forceps Pinza de agarre tipo caiman Pinza da presa tipo alligator con doppia articolazione</p>	R392-017400-011	R392-014400-011	R392-012400-011	R392-010400-011
 <p>Schere Scissor Tijera Forbici mono articolata</p>	R392-017400-021	R392-014400-021	R392-012400-021	R392-010400-021

Reda Instrumente GmbH
Gänsäcker 34 - P.O. Box 131
D-78532 Tuttlingen

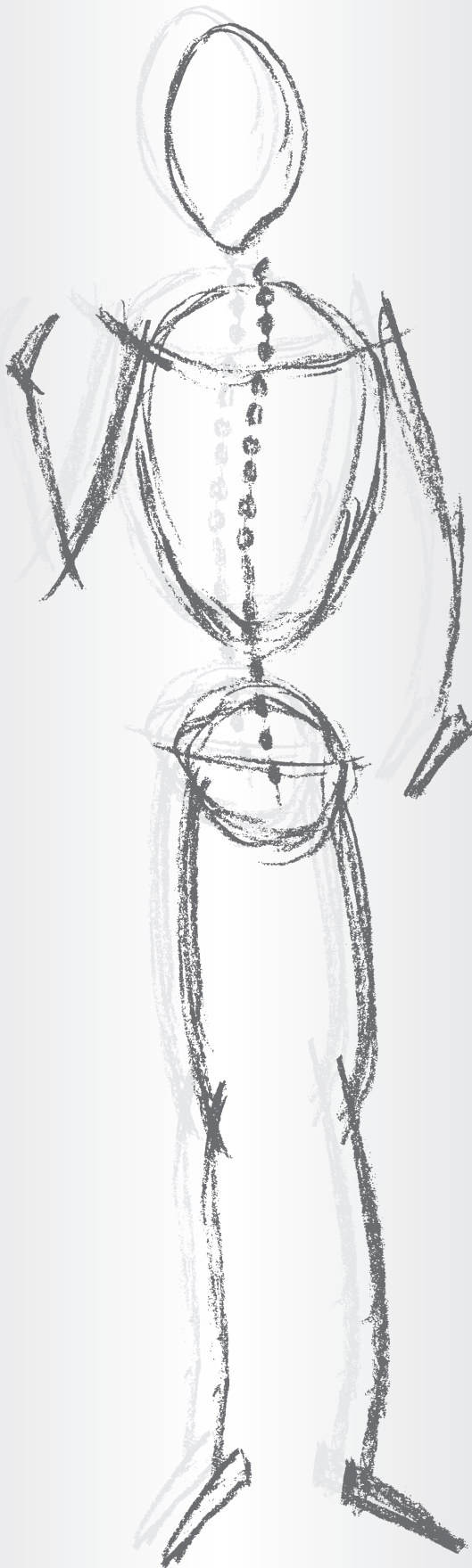

RESEKTOSKOPIE
für 2,9 mm Ø Optik

RESECTOSCOPY
for 2,9 mm Ø optic

RESECTOSCOPIA
para óptica 2,9 mm Ø

RESECTOSCOPIA
per ottica 2,9 mm Ø



www.Reda-Instrumente.de

Arbeitselement für Ø 2,9 mm Optik
Working element for Ø 2,9 mm optic
Vaina de trabajo para óptica de Ø 2,9 mm
Elemento di lavoro per ottico Ø 2,9 mm

"AKTIV", schneidend durch Fingerdruck
"ACTIVE", cutting by finger action
"ACTIVO", cortante por la presión del dedo
impugnatura con movimento "ATTIVO"

**R320-027225-11**

Griff geschlossen
Closed handle
Mango cerrado
Manico con anello chiuso

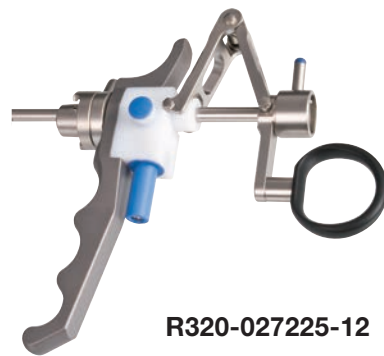
**R320-027225-12**

Griff offen
Opened handle
Mango abierto
Manico aperto

Arbeitselement "PASSIV", schneiden durch Federzug
Working element "PASSIVE", cutting by spring action
Elemento de trabajo "PASSIVO", cortante por balancin
Elemento di lavoro con movimento "PASSIVO"

**R320-027225-01**

Griff geschlossen
Closed handle
Mango cerrado
Manico con anello chiuso

**R320-027225-02**

Griff offen
Opened handle
Mango abierto
Manico aperto

Hochfrequenzkabel, monopolar, für Geräte von:
High frequency cable, monopolar, for devices of:
Cable monopolar de alta frecuencia, para equipos de:
Cavo monopolare ad alta frequenza per apparecchi:



4 mm

Eschmann alte Gerät, Erbe T-Serie old units
R329-040000-003 3 mtr.
R329-040000-005 5 mtr.



4 mm

Aesculap, Berchtold, Martin
R329-040000-203 3 mtr.
R329-040000-205 5 mtr.



5 mm

Erbe, Storz
R329-050000-003 3 mtr.
R329-050000-005 5 mtr.



8 mm

Valleylab
R329-080000-003 3 mtr.
R329-080000-005 5 mtr.

Dauerspül Resektoskop-Schäfte
Resectoscope sheats, continuous flow
Vaina para resectoscopio con flujo continuo
Camicia resettore, a aspirazione continua

**Ø [Char]**

Innenschaft, 1 Spülhahn fest mit LL-Adapter
Inner Sheat, 1 irrigation stop cock with LL-adapter
Vaina interior, 1 valvula de irrigacion rigida con adaptador de LL
Camicia interna, con 1 Rubinetto ingresso LL

19

Drehbar
Rotatable
rotable

R320-190000-130

Nicht drehbar
Not rotatable
non rotabile

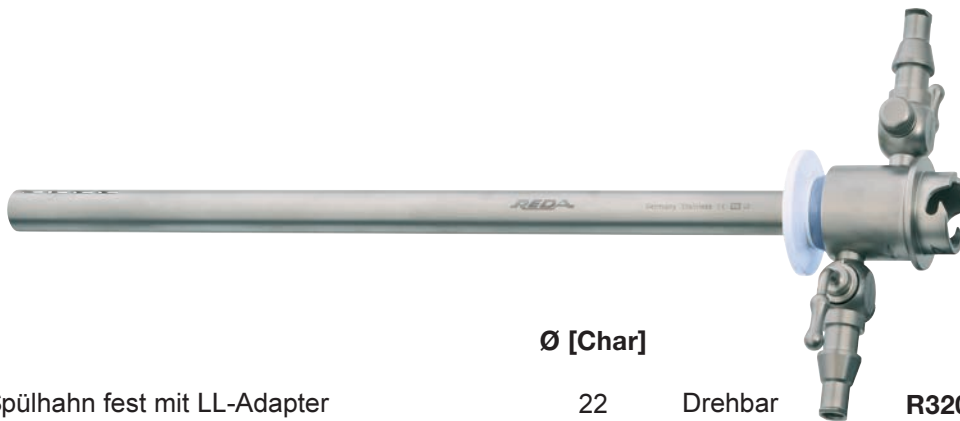
R320-190000-030**Ø [Char]**

Außenschaft, 1 Spülhahn fest mit LL-Adapter
Outer Sheat, 1 irrigation stop cock with LL-adapter
Vaina exterior, 1 valvula de irrigacion rigida con adaptador de LL
Camicia esterna, con 1 rubinetto ingresso LL

22

Drehbar
Rotatable
rotable

R320-220000-130

Nicht drehbar
Not rotatable
non rotabile

R320-220000-030

Dauerspül Resektoskop-Schäfte
Resectoscope sheats, continuous flow
Vaina para resectoscopia con flujo continuo
Camicia resettore, a aspirazione continua



Ø [Char]

Kombinierte Schäfte
Combi sheats
Vainas combinadas
Camicia con combinazione

19 / 22

Drehbar
Rotatable
rotable

R320-220190-130

Nicht drehbar
Not rotatable
non rotatable

R320-220190-030

Resektoskopie Obturatoren
Resectoscopy obturators
Obturadores para resectoscopia
Otturatori per resettoscopia



Standard Obturator
Standard obturators
Obturador estandar
Standard otturatore

Ø [Char]
19

R320-190000-001



Sicht-Obturator
Visual Obturator
Obturador visual
Otturatore diagnostico per visualizzazione diretta

Ø [Char]
19

ohne Kanal
without channel
sin canal

R320-190000-003

Monopolare Elektroden
Monopolar electrodes
Electrodos monopolares
Elettrodo monopolare

Ø 19 [Char]



Schlinge retrograde gebogen
Loop, retrograde curved
Asa, curva retrogradamente
Ansa per taglio, angolata

R329-190000-001

(for 0° Optic)

R329-190030-001

(for 12° Optic)



Kugel
Ball
Bola
Sferico

R329-190040-002

(Ø 2 mm)

R329-190040-003

(Ø 3 mm)



Rolle
Roller barrel
Rollo
Rullo

R329-190050-003

(Ø 3 mm)



Messer
Knife
Cuchillo
Elettrodo di coagulazione a bisturi

R329-190070-001



INSTRUMENTE GMBH

Reda Instrumente GmbH
Gänsäcker 34 - P.O. Box 131
D-78532 Tuttlingen

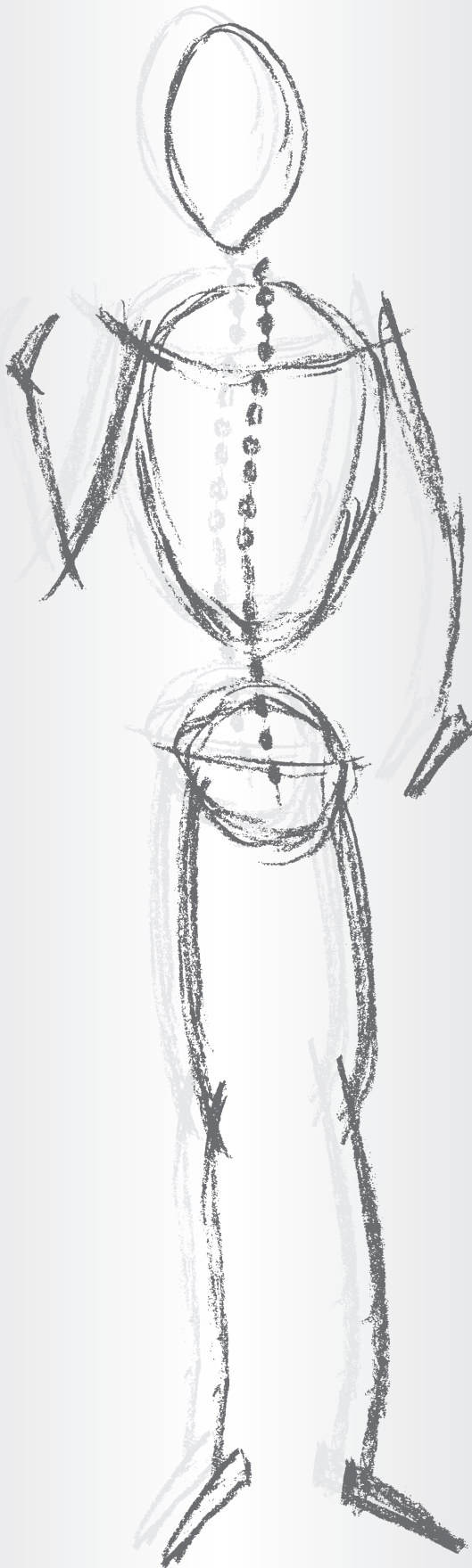

URETHROTOMIE

für 2,9 mm Ø Optik

URETHROTOMY

for 2,9 mm Ø optic

URETRÓTOMO

para óptica 2,9 mm Ø

URETROTOMO

per ottica 2,9 mm Ø



www.Reda-Instrumente.de

Urethrotomie
Urethrotomy
Uretrotomia
Uretrotomia

**R330-155201-01**

Urethrotomschaft 15,5 Char Ø graduiert seitlicher Kanal f. 3 Char Instrumente
Urethrotome sheath 15,5 Char Ø, graduated lateral channel f. 3 Fr. Instruments
Vaina para uretrotomo de 15,5 Char Ø con canal graduado lateral para instrumentos de 3. Char
Camicia per uretrotomo 15,5 Char Ø con scale graduate dotato di canale operativo

**R330-155201-102**

Zusatzschaft für Urethrotomschaft 15,5 Char Ø, seitlich offen
Supplementary sleeve for urethrotom-sleeve 15,5 Char Ø, lateral open
Vaina adicional para uretrótomo de 15,5 Char Ø, apertura lateral
Camicia supplementare per uretrotomo 15,5 Char Ø, aperta laterale



R330-155000-11

Urethrotom Standard Obturator für 15,5 Char Ø Schaft R330-155201-01
Urethrotome standard obturator for 15,5 Char Ø sheath R330-155201-01
Obturador estándar para uretrótomo de 15,5 Char Ø vaina R330-155201-01
Otturatore per camicia per uretrotomo 15,5 Char Ø R330-155201-01

R339-029000-001

Optikbrücke mit 3 Char Ø Arbeitskanal
Telescope bridge w. 3 Char Ø working channel
Puente para optica con canal de trabajo de 3 Char Ø
Ponticello uretrotomo per strumenti 3 Char Ø

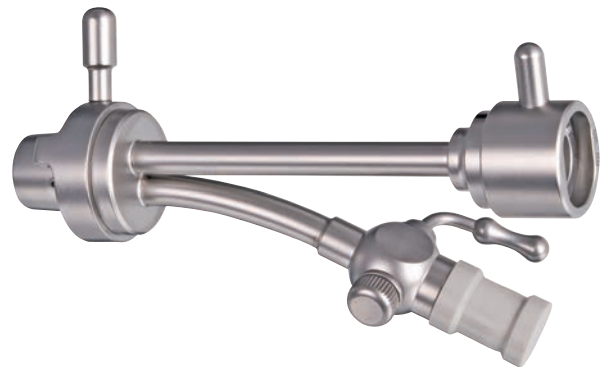

Strikturmesser
Cold knife
Cuchillo de corte frio
Lama uretrotomo per taglio a freddo



R339-155000-001
gerade
straight
recto
retto



R339-155000-002
Wellenschliff
wave shaped
filo ondulado
affilatura ondulata



R339-155000-011
rund
round shaped
semicircular
semisferico



R339-155000-031
sichelförmig
sickle shaped
en forma de hoz
ad uncino

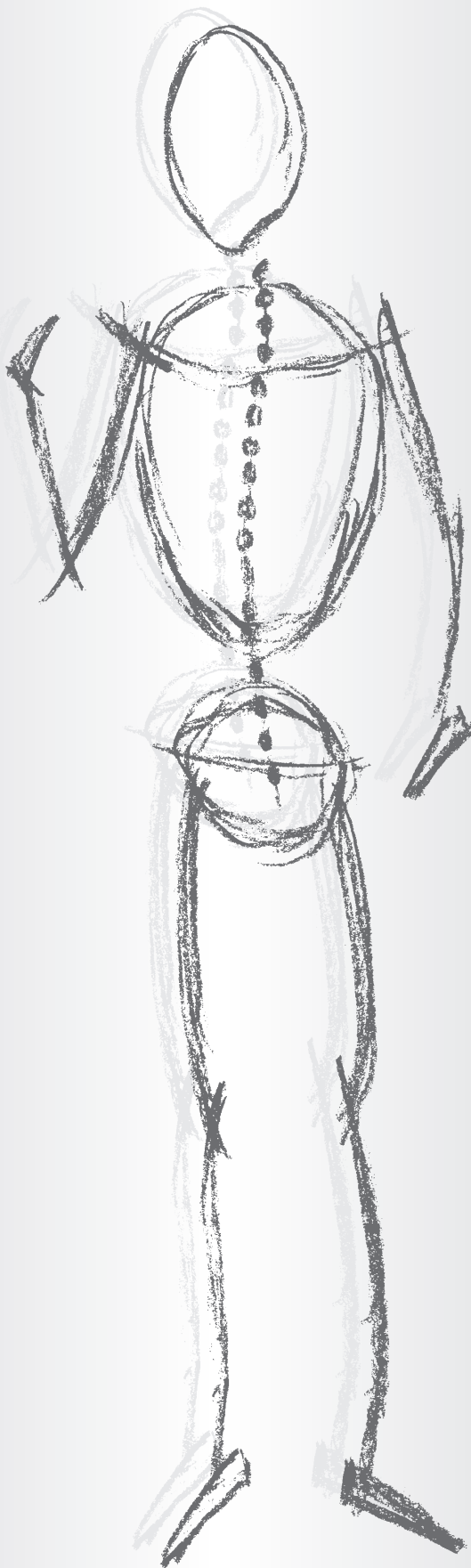

Reda Instrumente GmbH
Gänsäcker 34 - P.O. Box 131
D-78532 Tuttlingen

PÄDIATRISCHE UROLOGIE
Cystoskopie und Resektoskopie
9,5 & 11 Char Ø

PEDIATRIC UROLOGY
Cystoscopy and Resectoscopy
9,5 & 11 Fr. Ø

UROLOGÍA PEDIÁTRICA
Cistoscopia y Resectoscopia
9,5 & 11 Char Ø

UROLOGIA PEDIATRICA
Cistoscopia e Resettoscopia
9,5 & 11 Char Ø



www.Reda-Instrumente.de

Optik
Optic
Óptica
Ottica



Blickrichtung
Angle of view
Dirección visual
Angolo di visione

Ø 2,0 mm

0° **R300-020188-000**

30° **R300-020188-030**

Cystoskop-Schäfte, Kinder
Cystoscopy sheaths, Children
Vainas para cistoscopio, pediatricos
Camicie per cistoscopio, Pediatrico

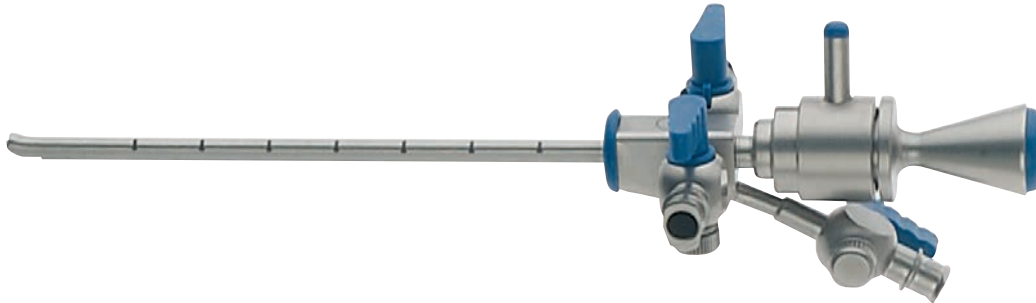

Ø [Char]

Cystoskop-Schaft, 2 Hähne fest mit LL-Adapter
Cystoscopy sheath, 2 stop cocks fixed with LL-adapters
Camisa para cistoscopio, 2 valvulas con adaptador de LL
Camicia per cistoscopio, 2 rubinetti fissi con adattatore LL

9,5	Obturator	R310-095000-001
	Sheath	R310-095120-001
	Sheath + Obturator	R311-095120-001

11	Obturator	R310-110000-001
	Sheath	R310-110120-001
	Sheath + Obturator	R311-110120-001

Flexible Instrumente
Flexible instruments
Instrumentos flexible
Instrumenti Flessibili

Instrumente 30 cm lang
Instruments 30 cm long
Instrumentos de 30 cm largo
Instrumenti lunghezza 30 cm



Biopsiezange
Biopsy forceps
Pinza de biopsia
Pinza per biopsia doppia articolazione

Ø 3 [Char]

R392-010300-001



Alligatorfaßzange
Alligator grasping forceps
Pinza de agarre
Pinza da presa tipo alligator doppia articolazione

R392-010300-011



Schere
Scissor
Tijera
Forbici mono articolata

R392-010300-021



Löffel oval
Spoon Forceps
Cuchara oval
Cucchiaio ovale con
denti aggressivi

R392-010300-005

Resektoskop für Kinder
 Resectoscope for children
 Resectoscopio para niños
 Resettore pediatrico

Arbeitselement
 Working element
 Vaina de trabajo
 Elemento di lavoro

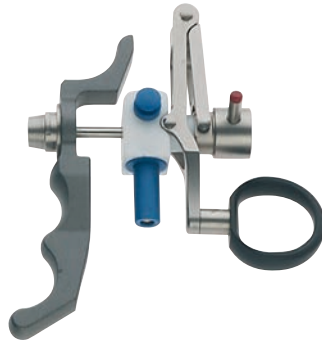

R320-027110-01
 (passiv/passive/pasivo/passivo)



R320-110110-030
 Resektoskop-Schaft Ø 11 Char
 Resectoscope sheat Ø 11 Char
 Vaina para resectoscopio de Ø 11 Char
 Camicia resettore Ø 11 Char

R320-110000-001
 Obturator Ø 11 Char
 Obturator Ø 11 Char
 Obturador Ø 11 Char
 Otturatore Ø 11 Char

Monopolare Elektroden
 Monopolar electrodes
 Electrodo monopolar
 Elettrodo Monopolare

Ø 11 [Char]

R329-110000-001



Schlinge retrograde gebogen
 Loop, retrograde curved
 Asa, curva retrogradamente
 Ansa per taglio, angolata

R329-110000-002



Schlinge retrograde gebogen #2
 Loop, retrograde curved #2
 Asa, curva retrogradamente #2
 Ansa per taglio, angolata #2

R329-110040-002
 (Ø 2 mm)



Kugel
 Ball
 Bola
 Sferico

R329-110070-001



Messer
 Knife
 Cuchillo
 Elettrodo di coagulazione a bisturi

Urethrotomie Kleinkinder
Urethrotomy infant
Uretrotomia para niños
Uretrotomia pediátrico

System für Ø 2,0 mm Optiken
System for Ø 2,0 mm telescopes

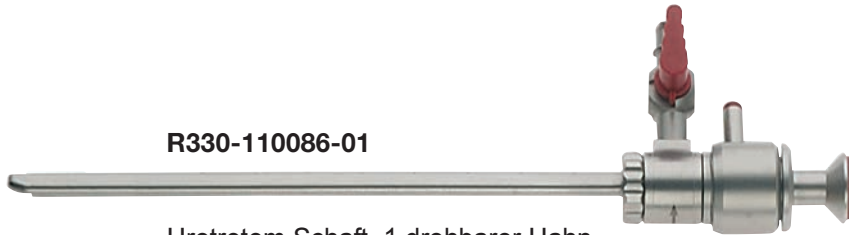
R330-110086-01

11 Fr.

Urethrotom Schaft, 1 drehbarer Hahn
Urethrotome sheath, 1 turnable stopcock
Vaina para uretrótomo, 1 llave rotatable
Camicia per uretrotomo, 1 rubinetto girevole

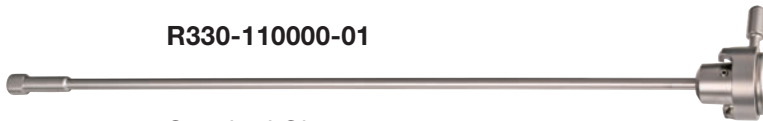
R330-110000-01

11 Fr.

Standard Obturator
Obturator standard
Obturador estándar
Otturatore standard

R330-020110-01

Arbeitselement, passiv
Working element, passive
Vaina de trabajo, pasivo
Elemento di lavoro, passivo

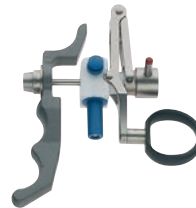

11 Fr.

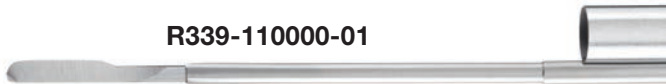
R339-110000-01

11 Fr.

gerade / straight / recto / retto

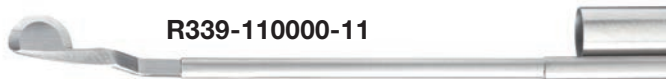
R339-110000-11

11 Fr.

rund / round shaped / semicircular / semisferico

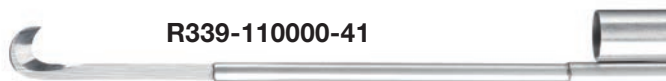
R339-110000-41

11 Fr.

sichelförmig / sickle shaped / en forma de hoz / ad uncino

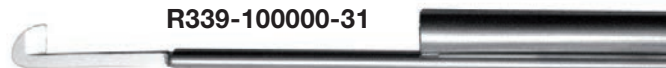
R339-100000-31

11 Fr.

hakenförmig / hook shaped / en forma de gancho / ad uncino

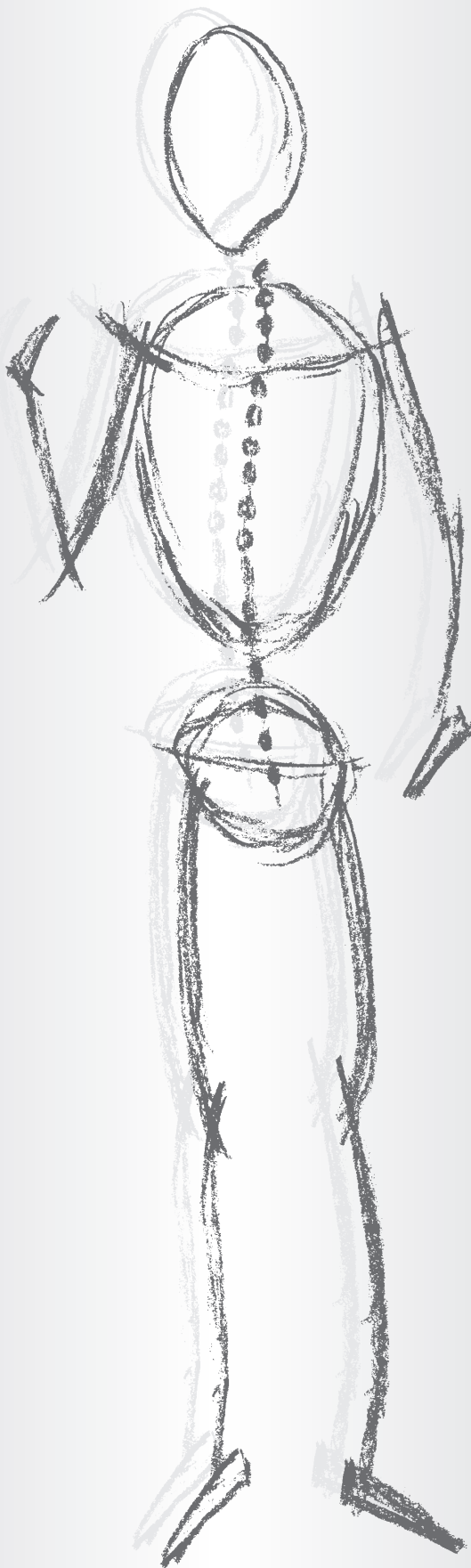

Reda Instrumente GmbH
Gänsäcker 34 - P.O. Box 131
D-78532 Tuttlingen

PÄDIATRISCHE UROLOGIE
Cystoskopie und Resektoskopie
13 Char Ø

PEDIATRIC UROLOGY
Cystoscopy and Resectoscopy
13 Fr. Ø

UROLOGÍA PEDIÁTRICA
Cistoscopia y Resectoscopia
13 Char Ø

UROLOGIA PEDIATRICA
Cistoscopia e Resettoscopia
13 Char Ø



www.Reda-Instrumente.de

Optik
Optic
Óptica
Ottica



Blickrichtung
Angle of view
Dirección visual
Angolo di visione

Ø 2,7 mm / length 187 mm

0°	R300-027188-000
30°	R300-027188-030
70°	R300-027188-070

Cystoskop-Schäfte, Kinder
Cystoscopy sheaths, Children
Vainas para cistoscopia, pediátricos
Camicie cistoscopia, Pediatrico



Ø [Char]

Cystoskop-Schaft, 2 Hähne fest mit LL-Adapter
Cystoscopy sheath, 2 stop cocks fixed with LL-adapters
Camisa para cistoscopia, 2 valvulas con adaptador de LL
Camicia per cistoscopia, 2 rubinetti fissi con adattatore LL

13	Obturator	R310-130000-001
	Sheath	R310-130120-001
	Sheath + Obturator	R311-130120-001



Ø [Char]

Albarran Lenkhebel
Albarran deflector
Palanca conductor tipo Albarran
Leva di Albarran

13		R310-027000-011
----	--	------------------------



Ø [Char]

Optikbrücke
Telescope bridge
Puente para óptica
Ponte diagnostico

13		R310-027000-000
----	--	------------------------

Flexible Instrumente
Flexible instruments
Instrumentos flexible
Instrumenti Flessibili

Imstrumente 30 cm lang
Instruments 30 cm long
Instrumentos de 30 cm largo
Instrumenti lunghezza 30 cm



Biopsiezange
Biopsy forceps
Pinza de biopsia
Pinza per biopsia doppia articolazione

Ø 3 [Char]

R392-010300-001



Alligatorfaßzange
Alligator grasping forceps
Pinza de agarre
Pinza da presa tipo alligator doppia articolazione

R392-010300-011



Schere
Scissor
Tijera
Forbici mono articolata

R392-010300-021



Löffel oval
Spoon Forceps
Cuchara oval
Cucchiaio ovale con
denti aggressivi

R392-010300-005

Resektoskop für Kinder
 Resectoscope for children
 Resectosopio para niños
 Resettore pediatrico

Arbeitselement
 Working element
 Vaina de trabajo
 Elemento di lavoro



R320-027110-01
 (passiv/passive/pasivo/passivo)



R320-130110-030
 Resektoskop-Schaft Ø 13 Char
 Resectoscope sheat Ø 13 Char
 Vaina para resectoscopio de Ø 13 Char
 Camicia resettore Ø 13 Char

R320-130000-001
 Obturator Ø 13 Char
 Obturator Ø 13 Char
 Obturador Ø 13 Char
 Otturatore Ø 13 Char

Monopolare Elektroden
 Monopolar electrodes
 Electrodo Monopolares
 Monopolar elettrodo

Ø 13 [Char]



Schlinge retrograde gebogen
 Loop, retrograde curved
 Asa, curva retrogradamente
 Ansa per taglio, angolata

R329-130000-001



Schlinge retrograde gebogen #2
 Loop, retrograde curved #2
 Asa, curva retrogradamente #2
 Ansa per taglio, angolata #2

R329-130000-002



Kugel
 Ball
 Bola
 Sferico

R329-130040-002
 (Ø 2 mm)



Messer
 Knife
 Cuchillo
 Elettrodo di coagulazione a bisturi

R329-130070-001

Urethrotomie Kinder
Urethrotomy children
Uretrotomia para niños
Uretrotomia pediatrico

System für Ø 2,7 mm Optiken
System for Ø 2,7 mm telescopes

R330-130086-01

13 Fr.

Urethrotom Schaft, 1 drehbarer Hahn
Urethrotome sheath, 1 turnable stopcock
Vaina para uretrótomo, 1 llave rotatable
Camicia per uretrotomo, 1 rubinetto girevole

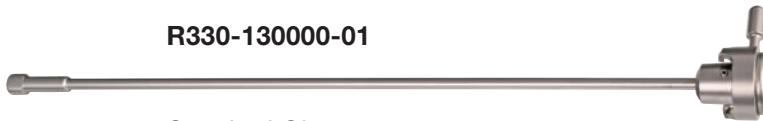
R330-130000-01

13 Fr.

Standard Obturator
Obturator standard
Obturador estándar
Otturatore standard

R320-027110-01

Arbeitselement, passiv
Working element, passive
Vaina de trabajo, pasivo
Elemento di lavoro, passivo

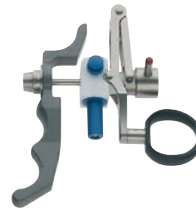

13 Fr.

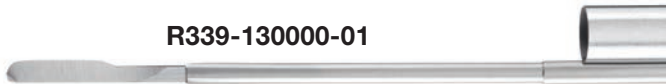
R339-130000-01

13 Fr.

gerade / straight / recto / retto

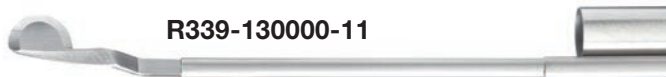
R339-130000-11

13 Fr.

rund / round shaped / semicircular / semisferico

R339-130000-41

13 Fr.

sichelförmig / sickle shaped / en forma de hoz / ad uncino

R339-130000-31

13 Fr.

hakenförmig / hook shaped / en forma de gancho / ad uncino

Reda Instrumente GmbH
Gänsäcker 34 - P.O. Box 131
D-78532 Tuttlingen

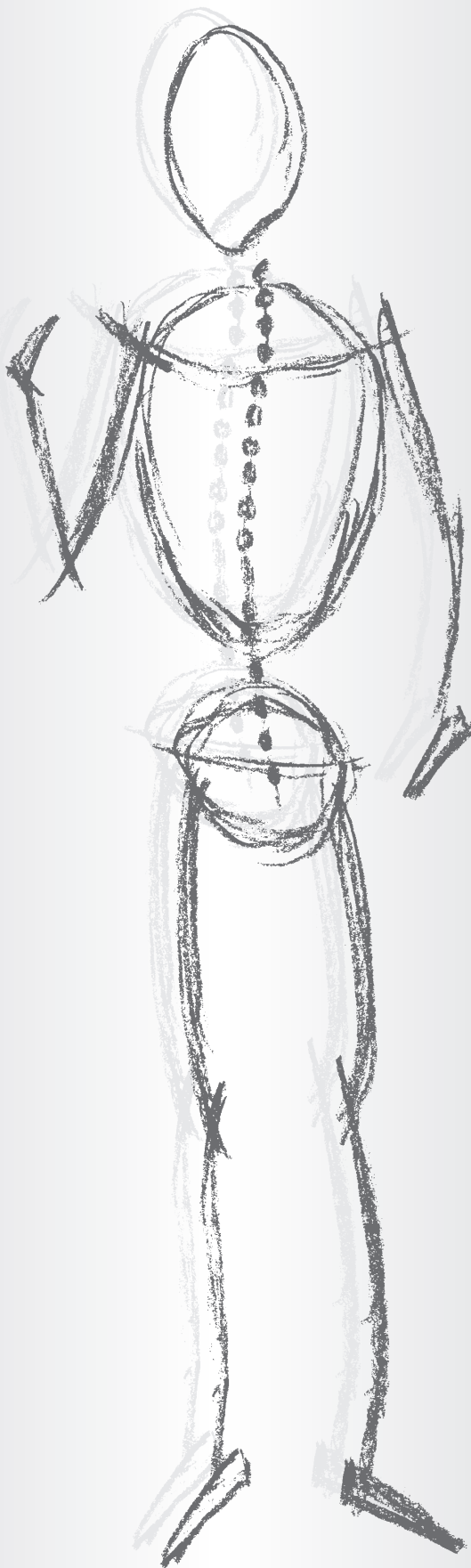

NEPHROSKOPIE

NEPHROSCOPY

NEFROSCOPIÁ

NEFROSCOPIA



www.Reda-Instrumente.de

Nephroskopie
Nephroscopy
Nefroscopía
Nefroscopia

Nephroskop 7,45 mm Ø, 0° Blickrichtung, autoklavierbar
Nephroscope 7,45 mm Ø, 0° angle of view, autoclaveable
Nefroscopio de 7,45 mm Ø, 0° Dirección visual, autoclavable
Nefroscopio 7,45 mm Ø, 0° Angolo di visione, autoclavabile

200 mm	R303-075200-000
250 mm	R303-075250-000
200 mm	R303-075200-090
250 mm	R303-075250-090

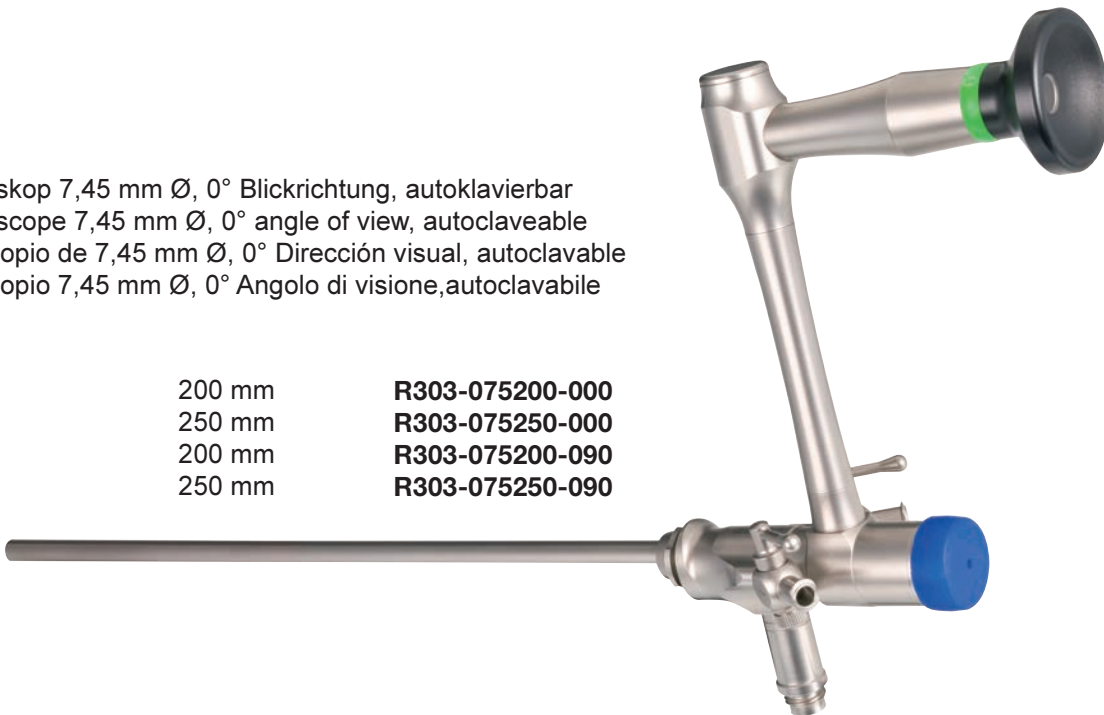

Nephroscope Operationsschaft, 1 Hahn drehbar
Nephroscopy operating sheath, 1 stop cock rotatable
Vaina para nefroscopio, 1 valvula rotable
Camicia per nefroscopio, 1 rubinetto girevole

20 cm 24 Char	R340-240200-002
25 cm 24 Char	R340-240250-002
20 cm 26 Char	R340-260200-002
25 cm 26 Char	R340-260250-002



Obturator für Nephroskop-Schaft und Fascien Dilatator mit Kanal für Führungsdrähte
Hollow Obturator and Fascial Dilator for Nephroscop sheath
Obturator para vaina para nefroscopio y dilatador fascial con canal para guias
Otturatore per camicia nefroscopio e dilatatore fasciale

20 cm 24 Char	R340-240200-001
25 cm 24 Char	R340-240250-001
20 cm 26 Char	R340-260200-001
25 cm 26 Char	R340-260250-001



Ø [Char]

9	R350-090000-001
12	R350-120000-001
15	R350-150000-001
18	R350-180000-001
21	R350-210000-001
24	R350-240000-001
27	R350-270000-001
30	R350-300000-001

R350-000000-199

Set für Teleskop Bougies Ø 9 - 24 Char
Set for telescope bougies Ø 9 - 24 Char
Set para dilatadores telescopicos Ø 9 - 24 Char
Set per dilatatori telescopio Ø 9 - 24 Char





R350-000200-001 (ohne Abb.)

Führungssonde, flexibel
Guide wire, flexible
Guia, flexible
Sonda guida, flessibile

R350-000100-001 (ohne Abb.)

starr
rigid
rigido
rigido

Instrumente Nephroskopie
 Instruments nephroscopy
 Instrumentos para Nefroscopia
 Instrumenti per Nefroscopia

		30 cm	40 cm
	Biopsiezange Biopsy forceps Pinza de biopsia Pinza per biopsia con doppia articolazione	R396-030300-001	R396-030400-001
	Löffel oval Spoon Forceps Cuchara oval Cucchiaino ovale con denti aggressivi	R396-030300-003	R396-030400-003
	Alligatorfaßzange Alligator grasping forceps Pinza de agarre Pinza da presa tipo alligator con doppia articolazione	R396-030300-011	R396-030400-011
	Schere Scissor Tijera Forbici mono articolata	R396-030300-021	R396-030400-021
	Hakenschere Hook scissor Tijera en forma de gancho Forbici rette uncinatae mono articolate	R396-030300-023	R396-030400-023

Reda Instrumente GmbH
Gänsäcker 34 - P.O. Box 131
D-78532 Tuttlingen

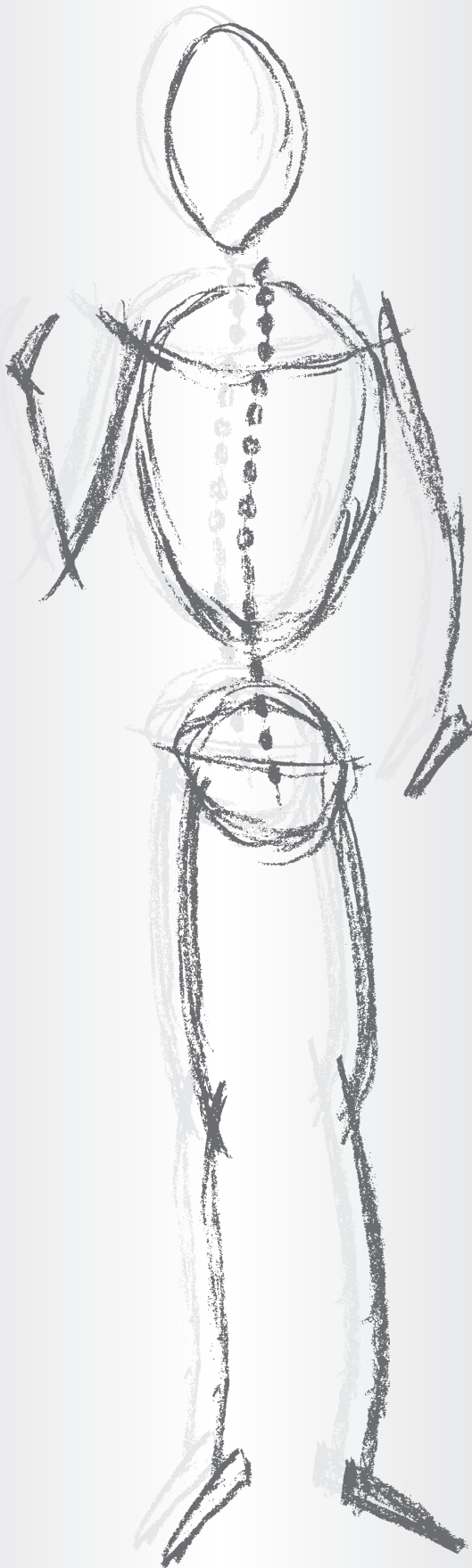

URETERO-RENOSKOPIE

URETERO-RENOSCOPY

URETERO-RENOSCOPIÁ

URETERO-RENOSCOPIA





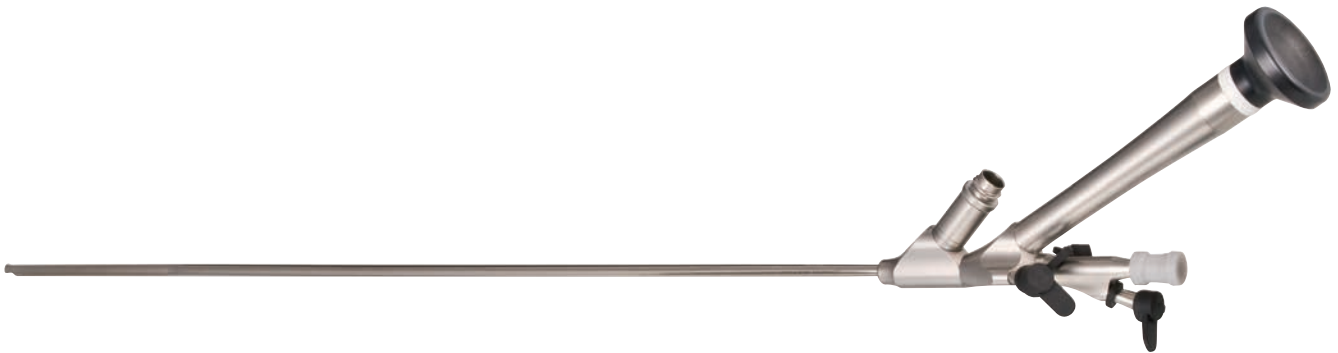

www.Reda-Instrumente.de

Uretero-Renoskope
Uretero-Renoscopes
Uretero-Renoscopio
Uretero-Renoscopio









Ø [Char]	Ø Arbeitskanal [Char] Ø Working channel [Char] Ø Canal de trabajo [Char] Ø Canale di lavoro [Char]	Nutzlänge Working length Longitud util Lunghezza operativa	Blickrichtung 8° Angle of view 8° Dirección visual 8° Angolo di visione 8°
6 - 9	4	310 mm	R302-060310-008
6 - 9	4	425 mm	R302-060425-008
7,5 - 10	5	310 mm	R302-075310-008
7,5 - 10	5	425 mm	R302-075425-008



	Ø 3 [Char] Fr.	Ø 3,5 [Char] Fr.	Ø 4 [Char] Fr.	Ø 5 [Char] Fr.
 <p>Biopsiezange Biopsy forceps Pinza para biopsia Pinza per biopsia</p>	R392-010600-001	R392-012600-001	R392-014600-001	R392-017600-001
 <p>Löffelzange gezahnt Spoon forceps serrated Pinza de cuchara dentada Pinza per la rimozione</p>		R392-012600-008	R392-014600-008	R392-017600-008
 <p>Löffelzange lang gezahnt Spoon forceps long serrated Pinza de cuchara, larga dentada Pinza da presa</p>				R392-017600-006
 <p>Löffelzange kurz gezahnt Spoon forceps short serrated Pinza de cuchara, corta dentada Pinza da presa</p>		R392-012600-007		R392-017600-007
 <p>Faßzange gezahnt Grasping forceps serrated Pinza de agarre dentada Pinza da presa</p>		R392-012600-010		

Flexible Instrumente 60 cm
 Flexible instruments 60 cm
 Instrumentos flexible 60 cm
 Instrumenti Flessibili 60 cm

		Ø 3 [Char] Fr.	Ø 3,5 [Char] Fr.	Ø 4 [Char] Fr.	Ø 5 [Char] Fr.
	Alligatorzange Alligator forceps serrated Pinza de agarre Pinza da presa tipo alligator	R392-010600-011	R392-012600-011	R392-014600-011	R392-017600-011
	Steinstrasse lang Grasping forceps Steinstrasse Pinza da calculos larga pinza de presa		R392-012600-013		R392-017600-013
	Fremdkörperzange Stein Foreign Body grasper stone Pinza para cuerpos extraños de calculos Pinza da presa per calculi		R392-012600-014		R392-017600-014
	3-Arm Greifer 3-prong grasper Pinza de agarre de 3 brazos Pinza tripode uncinata	R392-010600-015			R392-017600-015
	Rattenzahnfaßzange Rat tooth grasper Pinza de agarre con diente de raton Pinza da presa	R392-010600-016		R392-014600-016	R392-017600-016
	Fremdkörper Greifzange gefenstert Foreign body grasper fenestrated Pinza de agarre cuerpo extraño Pinza da presa per frammenti		R392-012600-017		R392-017600-017
	Ureter-Schlitzschere Uretero slitting scissors tijera para uréter forbici per incisione dell'uretere		R392-012600-025		R392-017600-025

Dormia Steinfänger
Dormia stone dislodger
Malla para rescatar calculus
Cestello dormia

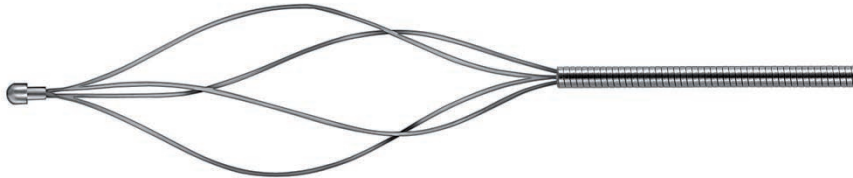

R394-010600-004

4 Drähte 3Char/1,0 mm Ø, 600 mm Nutzlänge
4 wires 3Fr./1,0 mm Ø, 600 mm work.length,
Malla de 4 alambre de 3 Char/1,0 mm para extraer calculos 600 mm de largo util
Cestello dormia 4 filamenti, lunghezza 600 mm, Ø1,0 mm

R394-017600-004

4 Drähte 5Char/1,7 mm Ø, 600 mm Nutzlänge
4 wires 5Fr./1,7 mm Ø, 600 mm work.length,
Malla de 4 alambres de 5 Char/1,7 mm para extraer calculos 600 mm de largo util
Cestello dormia 4 filamenti, lunghezza 600 mm, Ø1,7 mm

R394-017600-006

6 Drähte 5Char/1,7 mm Ø, 600 mm Nutzlänge
6 wires 5Fr./1,7 mm Ø, 600 mm work.length,
Malla de 6 alambres de 5 Char/1,7 mm para extraer calculos 600 mm de largo util
Cestello dormia 6 filamenti, lunghezza 600 mm, Ø1,7 mm



R394-000000-000

Griff für Dormia Steinfänger
handle for Dormia stone dislodger
mango para Malla para rescatar calculus
Impugnatura per Cestello dormia



INSTRUMENTE GMBH

Reda Instrumente GmbH
Gänsäcker 34 - P.O. Box 131
D-78532 Tuttlingen

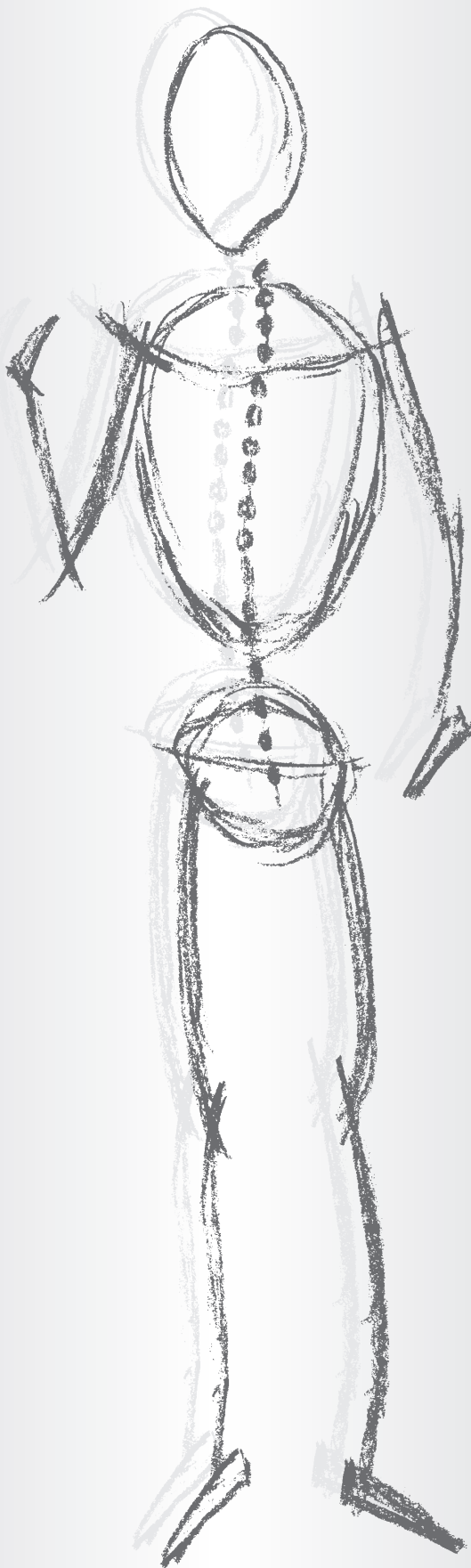

ZUBEHÖR

ACCESSORIES

ACCESORIOS

ACCESSORI



www.Reda-Instrumente.de

Zubehör Urologie
Accessories Urology
Accesorios para urologia
Accessori Urologia

**67175-08**

STOCKMANN Penisklemme
STOCKMANN penis seizing fcps.
STOCKMANN pinza p. el pene
STOCKMANN pinza serrapene

**67177-11**

STRAUSS Penisklemme
STRAUSS penis clamp
STRAUSS pinza p. el pene
STRAUSS pinza serrapene

Kathetereinführungsinstrumente, Dilatationsbougies
 Catheter Introducer, Dilating Bougies
 Introducitor de catéteres, Bujías dilatadoras
 Mandrini per sonde uretrali, Candelette dilatatrici

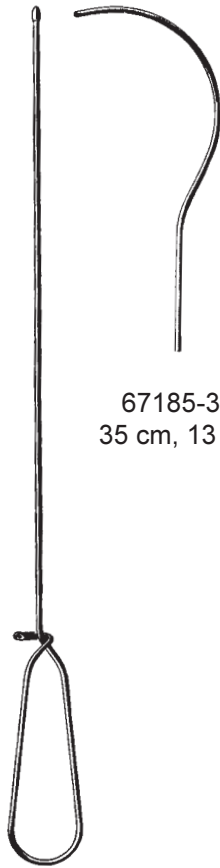

67185-35
 35 cm, 13 3/4"

GUYON
 67184-39
 39 cm, 15 1/2"



Charr. FG	28 cm (11") VAN BUREN	25 cm (10") GUYON	28 cm (11") DITTEL	30 cm (11 3/4") DITTEL
8	67201-08	67205-08	67206-08	67207-08
9			67206-09	67207-09
10	67201-10	67205-10	67206-10	67207-10
11			67206-11	67207-11
12	67201-12	67205-12	67206-12	67207-12
13			67206-13	67207-13
14	67201-14	67205-14	67206-14	67207-14
15			67206-15	67207-15
16	67201-16	67205-16	67206-16	67207-16
17			67206-17	67207-17
18	67201-18	67205-18	67206-18	67207-18
19			67206-19	67207-19
20	67201-20	67205-20	67206-20	67207-20
21			67206-21	67207-21
22	67201-22	67205-22	67206-22	67207-22
23			67206-23	67207-23
24	67201-24	67205-24	67206-24	67207-24
25			67206-25	67207-25
26	67201-26	67205-26	67206-26	67207-26
27			67206-27	67207-27
28	67201-28	67205-28	67206-28	67207-28
29			67206-29	67207-29
30	67201-30	67205-30	67206-30	67207-30
32	67201-32	67205-32		
34	67201-34	67205-34		
36	67201-36	67205-36		
38		67205-38		
40		67205-40		

OTIS Urethrotom für Erwachsene
OTIS urethrotome for adults
OTIS uretrótomo para adultos
OTIS ureterotomo per adulti



Lieferumfang
extent of delivery

67169-00

OTIS Dilatator
OTIS dilatation
OTIS instrumento de dilatación
OTIS dilatatore



3 x Aufsätze (Kugel, Flach, Konisch)
3 x tips (ball, flat, conical)
juego de 3 x puntas (bola, plana, cónica)
set di 3 x punte (a sfera, piatta e conica)

**67169-01**

2 x Messer
2 x knives
2 x cuchillos
2 x bisturi

1 x Box



Blasenspritzen
Bladder springs
Jeringa para vejiga
Siringa vescicale



Blasenspritze
Bladder spring
Jeringa para vejiga
Siringa vescicale

Ersatzzylinder
Spare barrels
Cilindros de repuesto
Cilindri di ricambio

50ml	R390-000050-001
75ml	R390-000075-001
100ml	R390-000100-001
150ml	R390-000150-001

R390-000050-999
R390-000075-999
R390-000100-999
R390-000150-999

Evakuator nach ELLIK
Evacuator acc to ELLIK
Evacuador segun ELLIK
Evacuatore sec. ELLIK



R390-100000-000
Komplett
complete
completo
completo

R390-100000-100
Gummiball
Rubber ball
Pera de goma
Pompetta in gomma

R390-100000-300
Schlauch mit Verriegelungs-Adapter
Tube with locking device
Tubo con adattador
Tubo con adattatore

R390-100000-200
Glasbehälter
Glass recipient
Recipiente de vidrio
Recipiente in vetro

R390-100000-400
Konus mit Schlauchteil
Cone adapter with tube
Cono con tubo
Cono con segmento di Tubo

Zubehör Urologie
Accesories Urology
Accesorios para urologia
Accessori Urologia

Luerlock-Schlauchverbinder
luer-lock tubing connector
luer-luck conector para el tubo
luer-lock connettore per tubi



R070-000060-101
männlich
male
macho
maschio



R070-000060-201
weiblich
female
femenino
femminile

Luerlock-Schlauchverbinder mit Hahn
luer-lock tubing connector with stopcock
luer-lock conector para el tubo con llave
luer-lock connettore per tubi; con rubinetto

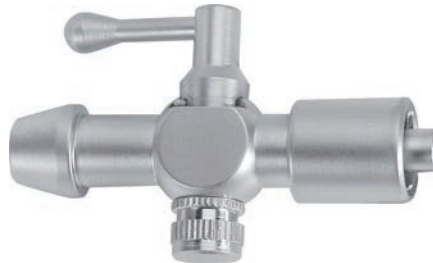

R070-000060-001
männlich
male
macho
maschio

R070-000060-301
weiblich
female
femenino
femminile

Adapter für Blasenkatheter
Adapter for bladder catheter
Adaptador para Catéter
Adattore per Catetero



R390-9001

Dichtkappe für Instrumentenkanal
sealing cap for instrument channel
capuchon de cierre para canal de instrumentos
tappino in gomma; per canale strumenti



R210-000010-011
1 mm

R210-000020-011
2 mm

67169-00UR76	67206-21UR75	R300-040302-070UR 8
67169-01UR76	67206-22UR75	R302-060310-008UR68
67175-08UR74	67206-23UR75	R302-060425-008UR68
67177-11UR74	67206-24UR75	R302-075310-008UR68
67184-39UR75	67206-25UR75	R302-075425-008UR68
67185-35UR75	67206-26UR75	R303-075200-000UR64
67201-08UR75	67206-27UR75	R303-075200-090UR64
67201-10UR75	67206-28UR75	R303-075250-000UR64
67201-12UR75	67206-29UR75	R303-075250-090UR64
67201-14UR75	67206-30UR75	R310-027000-000UR59
67201-16UR75	67207-08UR75	R310-027000-011UR59
67201-18UR75	67207-09UR75	R310-029000-000UR36
67201-20UR75	67207-10UR75	R310-029000-001UR36
67201-22UR75	67207-11UR75	R310-029000-002UR36
67201-24UR75	67207-12UR75	R310-029000-011UR37
67201-26UR75	67207-13UR75	R310-029000-012UR37
67201-28UR75	67207-14UR75	R310-040000-000UR12
67201-30UR75	67207-15UR75	R310-040000-001UR12
67201-32UR75	67207-16UR75	R310-040000-002UR12
67201-34UR75	67207-17UR75	R310-040000-011UR13
67201-36UR75	67207-18UR75	R310-040000-012UR13
67205-08UR75	67207-19UR75	R310-040000-021UR13
67205-10UR75	67207-20UR75	R310-040000-022UR13
67205-12UR75	67207-21UR75	R310-095000-001UR53
67205-14UR75	67207-22UR75	R310-095120-001UR53
67205-16UR75	67207-23UR75	R310-110000-001UR53
67205-18UR75	67207-24UR75	R310-110120-001UR53
67205-20UR75	67207-25UR75	R310-130000-001UR59
67205-22UR75	67207-26UR75	R310-130120-001UR59
67205-24UR75	67207-27UR75	R310-150000-001UR35
67205-26UR75	67207-28UR75	R310-150235-001UR35
67205-28UR75	67207-29UR75	R310-170000-001UR10
67205-30UR75	67207-30UR75	R310-170000-003UR10
67205-32UR75	R070-000060-001UR78	R310-170235-001UR10
67205-34UR75	R070-000060-101UR78	R310-190000-001UR10
67205-36UR75	R070-000060-201UR78	R310-190000-003UR10
67205-38UR75	R070-000060-301UR78	R310-190235-001UR10
67205-40UR75	R210-000010-011UR78	R310-210000-001UR10
67206-08UR75	R210-000020-011UR78	R310-210000-003UR10
67206-09UR75	R300-020188-000UR52	R310-210235-001UR10
67206-10UR75	R300-020188-030UR52	R310-230000-001UR10
67206-11UR75	R300-027188-000UR58	R310-230000-003UR10
67206-12UR75	R300-027188-030UR58	R310-230235-001UR10
67206-13UR75	R300-027188-070UR58	R310-240000-001UR20
67206-14UR75	R300-029302-000UR34	R310-250000-001UR10
67206-15UR75	R300-029302-015UR34	R310-250000-003UR10
67206-16UR75	R300-029302-030UR34	R310-250235-001UR10
67206-17UR75	R300-029302-070UR34	R311-095120-001UR53
67206-18UR75	R300-040302-000UR 8	R311-110120-001UR53
67206-19UR75	R300-040302-015UR 8	R311-130120-001UR59
67206-20UR75	R300-040302-030UR 8	R311-150235-001UR35

R311-170235-001	UR10	R320-220190-130	UR43	R329-240054-003	UR28
R311-190235-001	UR10	R320-240000-001	UR26	R329-240054-005	UR28
R311-210235-001	UR10	R320-240000-002	UR26	R329-240055-001	UR27
R311-230235-001	UR10	R320-240000-003	UR26	R329-240056-001	UR27
R311-250235-001	UR10	R320-240000-005	UR26	R329-240070-001	UR28
R312-040000-01	UR20	R320-240000-030	UR24	R329-240090-003	UR28
R312-150000-001	UR11	R320-240000-130	UR24	R329-270000-001	UR27
R312-150235-001	UR11	R320-260000-030	UR24	R329-270010-001	UR27
R312-170235-001	UR11	R320-260000-130	UR24	R329-270030-001	UR27
R312-190235-001	UR11	R320-260240-030	UR25	R329-270040-003	UR27
R312-210235-001	UR11	R320-260240-130	UR25	R329-270040-005	UR27
R312-230235-001	UR11	R320-270000-001	UR26	R329-270050-003	UR27
R312-250235-001	UR11	R320-270000-002	UR26	R329-270050-005	UR27
R313-150235-001	UR11	R320-270000-003	UR26	R329-270055-001	UR27
R313-170235-001	UR11	R320-270000-005	UR26	R329-990	UR28
R313-190235-001	UR11	R320-270000-030	UR24	R330-110000-01	UR56
R313-210235-001	UR11	R320-270000-130	UR24	R330-110086-01	UR56
R313-230235-001	UR11	R320-285000-030	UR24	R330-130000-01	UR62
R313-240235-001	UR20	R320-285000-130	UR24	R330-130086-01	UR62
R313-250235-001	UR11	R320-285270-030	UR25	R330-155000-11	UR49
R315-021000-01	UR14	R320-285270-130	UR25	R330-155201-01	UR48
R315-021000-011	UR14	R329-040000-003	UR23	R330-155201-102	UR48
R315-021000-021	UR14	R329-040000-005	UR23	R330-210000-01	UR31
R315-021000-06	UR14	R329-040000-203	UR23	R330-210000-11	UR31
R315-021000-30	UR15	R329-040000-205	UR23	R330-210201-01	UR30
R315-021000-70	UR15	R329-050000-003	UR23	R330-230201-001	UR30
R315-240000-59	UR20	R329-050000-005	UR23	R330-230201-102	UR30
R315-250000-39	UR20	R329-080000-003	UR23	R339-029000-001	UR49
R315-901	UR15	R329-080000-005	UR23	R339-040000-001	UR31
R315-902	UR15	R329-110000-001	UR55	R339-110000-001	UR56
R319-900-01	UR13	R329-110000-002	UR55	R339-110000-011	UR56
R320-027110-01	UR55	R329-110040-002	UR55	R339-110000-031	UR56
R320-027225-01	UR40	R329-110070-001	UR55	R339-110000-041	UR56
R320-027225-02	UR40	R329-130000-001	UR61	R339-130000-001	UR62
R320-027225-11	UR40	R329-130000-002	UR61	R339-130000-011	UR62
R320-027225-12	UR40	R329-130040-002	UR61	R339-130000-031	UR62
R320-040225-01	UR22	R329-130070-001	UR61	R339-130000-041	UR62
R320-040225-02	UR22	R329-190000-001	UR45	R339-155000-001	UR50
R320-040225-11	UR22	R329-190030-001	UR45	R339-155000-002	UR50
R320-040225-12	UR22	R329-190040-002	UR45	R339-155000-011	UR50
R320-110000-001	UR55	R329-190050-003	UR45	R339-155000-031	UR50
R320-110110-030	UR55	R329-190070-001	UR45	R339-210000-001	UR32
R320-130000-001	UR61	R329-240000-001	UR27	R339-210000-002	UR32
R320-130110-030	UR61	R329-240010-001	UR27	R339-210000-011	UR32
R320-190000-001	UR44	R329-240030-001	UR27	R339-210000-021	UR32
R320-190000-003	UR44	R329-240040-003	UR27	R339-210000-031	UR32
R320-190000-030	UR42	R329-240040-005	UR27	R340-240200-001	UR64
R320-190000-130	UR42	R329-240050-003	UR27	R340-240200-002	UR64
R320-220000-030	UR42	R329-240050-005	UR27	R340-240250-001	UR64
R320-220000-130	UR42	R329-240052-003	UR28	R340-240250-002	UR64
R320-220190-030	UR43	R329-240052-005	UR28	R340-260200-001	UR64

R340-260200-002	UR64	R392-012600-013	UR70	R394-017600-004	UR18
R340-260250-001	UR64	R392-012600-014	UR70	R394-017600-006	UR18
R340-260250-002	UR64	R392-012600-017	UR70	R395-000000-000	UR19
R350-000000-199	UR65	R392-012600-025	UR70	R395-010450-001	UR19
R350-000100-001	UR65	R392-012800-025	UR70	R395-010450-021	UR19
R350-000200-001	UR65	R392-014400-001	UR38	R395-017400-125	UR19
R350-090000-001	UR65	R392-014400-011	UR38	R395-017450-001	UR19
R350-120000-001	UR65	R392-014400-021	UR38	R395-017450-011	UR19
R350-150000-001	UR65	R392-014600-001	UR69	R395-017450-021	UR19
R350-180000-001	UR65	R392-014600-008	UR69	R395-023400-125	UR19
R350-210000-001	UR65	R392-014600-011	UR70	R395-023450-001	UR19
R350-240000-001	UR65	R392-014600-016	UR70	R395-023450-011	UR19
R350-270000-001	UR65	R392-017400-001	UR16	R395-023450-021	UR19
R350-300000-001	UR65	R392-017400-003	UR16	R395-030450-001	UR19
R390-000050-001	UR77	R392-017400-005	UR16	R395-030450-011	UR19
R390-000050-999	UR77	R392-017400-011	UR17	R396-030300-001	UR66
R390-000075-001	UR77	R392-017400-021	UR17	R396-030300-003	UR66
R390-000075-999	UR77	R392-017600-001	UR69	R396-030300-011	UR66
R390-000100-001	UR77	R392-017600-006	UR69	R396-030300-021	UR66
R390-000100-999	UR77	R392-017600-007	UR69	R396-030300-023	UR66
R390-000150-001	UR77	R392-017600-008	UR69	R396-030400-001	UR66
R390-000150-999	UR77	R392-017600-011	UR70	R396-030400-003	UR66
R390-000200-001	UR77	R392-017600-013	UR70	R396-030400-011	UR66
R390-000200-999	UR77	R392-017600-014	UR70	R396-030400-021	UR66
R390-100000-000	UR77	R392-017600-015	UR70	R396-030400-023	UR66
R390-100000-001	UR77	R392-017600-016	UR70		
R390-100000-100	UR77	R392-017600-017	UR70		
R390-100000-200	UR77	R392-017600-025	UR70		
R390-100000-300	UR77	R392-021400-001	UR16		
R390-100000-400	UR77	R392-021400-003	UR16		
R390-9001	UR78	R392-021400-005	UR16		
R392-010300-001	UR54	R392-021400-006	UR16		
R392-010300-005	UR54	R392-021400-011	UR17		
R392-010300-011	UR54	R392-021400-021	UR17		
R392-010300-021	UR54	R392-023400-001	UR16		
R392-010400-001	UR38	R392-023400-003	UR16		
R392-010400-005	UR38	R392-023400-004	UR16		
R392-010400-011	UR38	R392-023400-005	UR16		
R392-010400-021	UR38	R392-023400-009	UR16		
R392-010600-001	UR69	R392-023400-011	UR17		
R392-010600-011	UR70	R392-023400-014	UR17		
R392-010600-015	UR70	R392-023400-021	UR17		
R392-010600-016	UR70	R392-023400-022	UR17		
R392-012400-001	UR38	R392-023400-023	UR17		
R392-012400-011	UR38	R392-030400-001	UR16		
R392-012400-021	UR38	R392-030400-003	UR16		
R392-012600-001	UR69	R392-030400-011	UR17		
R392-012600-007	UR69	R392-030400-021	UR17		
R392-012600-008	UR69	R392-030400-023	UR17		
R392-012600-010	UR69	R394-000000-000	UR18		
R392-012600-011	UR70	R394-010600-004	UR71		

Weitere Kataloge und Prospekte
Other catalogues and prospects

Hauptkatalog Chirurgische Instrumente
General catalog surgical instruments

Endoskopie
Endoscopy

Titan Instrumente
Titanium Instruments

Container Steriltechnik
Container Sterilization Technique

HERCULES® Drahtkneifzange
HERCULES® Wire Cutters

Neurochirurgie
Neuro surgery

Plastische Chirurgie
Plastic surgery

Orthopädie
Orthopedic

Arthroskopie
Arthroscopy



Gänsäcker 34
P.O. Box 131
D-78532 Tuttlingen
Germany



Fon +49 74 62.94 45-0
Fax +49 74 62.94 45-20
info@Reda-Instrumente.de
www.Reda-Instrumente.de